



Pulse SO

Modbus RTU
RI-F100-B-C / RI-F100-G-C

M-Bus
RI-F100-B-MB / RI-F100-G-MB



MID Installation must comply with MID certified requirements

MID Config Lock
>> see 'Configuration' for Lockable Settings

All terminal covers provided must be fitted. All cable connections and terminal covers of the meter and the CT must be secured with sealing hasp.

Once Configuration Mode is entered, 'MID Config Lock' will activate after 15 minutes or if meter is switched off. No further adjustment is possible for the lockable settings. Unlock only by returning to supplier.

Specifications		Accuracy					
Wiring Input	3Ø 4 wire (MID Approved) 3Ø 3 wire, 2Ø 3 wire, 1Ø 2 wire	Voltage V L-N and V L-L				±0.5% of full scale	
Rated Input Voltage	3x 11...300V AC (L-N), 19...519V AC (L-L)	Current				±0.5% of full scale	
Frequency Range	47...63Hz (MID approved @ 50Hz)	Frequency for L-N > 20V, L-L > 35V				±0.1% of full scale	
CT Primary	1A/5A...6,000A configurable	Active, Reactive and Apparent Power				1%	
CT Secondary	1A or 5A (MID approved for 5A only) max rating x1.2	Power Factor				±0.01 of Unity	
VT Primary	100...600V configurable	Active Energy				EN50470-3: Cl.B	
VT Secondary	173...415V AC (L-L) configurable	Reactive Energy				EN62053-23: Cl.2	
Auxiliary / Power consumption	100...240V AC (±15%), 47...65Hz / < 8VA	Apparent Energy				Class 1	
Display Update Rate	1 sec all parameters	Wh Resolution and Default Pulse Weight					
Operating / Storage Temperature	-10...55°C / -20...70°C	CT Ratio x VT Ratio	<15	<150	<1500	<15000	>15000
Humidity	0...85% non-condensing	Wh / VAh / VAh /	0.01k	0.1k	1k	0.01M	0.1M
Protection Degree (IEC/EN60529)	IP54 Front only (rubber gasket fitted)	Example If CT = 100/5A (CT ratio = 20) & VT = 350/350V (VT Ratio = 1) Wh resolution = 0.1kWh (20 x 1 = <150) Pulse O/P default = 0.1kWh/pulse					
Pulse Output	External 5...27V DC / 100mA max						
Pulse Resolution / Duration	0.01...99.99kWh per imp / 50...300mS						
Communication	Modbus RTU over RS485 Mbus (EN13757)						

! PRODUCT SAFETY

Safety related notification, symbols and instructions that appear in this operating manual or on the equipment must be strictly followed to ensure the safety of personnel as well as the instrument. If the equipment is not used in a manner specified by the manufacturer it may impair the protection provided by the equipment

- Do not use the equipment if there are mechanical damage
- Do not exceed the stated maximum ratings of the device
- No repairs, maintenance or adjustments are possible
- Read the complete instruction manual prior to installation or operating the unit
- The equipment in its installed state must not come into close proximity to any heating sources, oils, steam, caustic vapours or other unwanted process by-products
- Do not use in hazardous or classified location where explosion or other dangers can be triggered by the device

! INSTALLATION PRECAUTIONS

Risk of electric shock!
Only to be installed by a competent person

- To prevent the risk of electrocution, always isolate and lock-off the power supply to the equipment prior to undertaking any work
- Always confirm absence of electricity prior to starting work using appropriate voltage detection equipment
- Wiring shall be done strictly according to the terminal layout
- Confirm that all connections are correct before energizing the equipment
- Routing of cables shall be way from any internal EMI source
- Copper cable should be used
- All wiring to be in accordance with applicable local standards

WIRING

3P4W
3 CTs

MID ✓

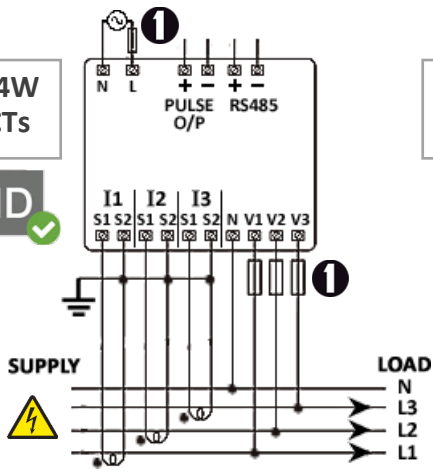

3P3W
2 CTs

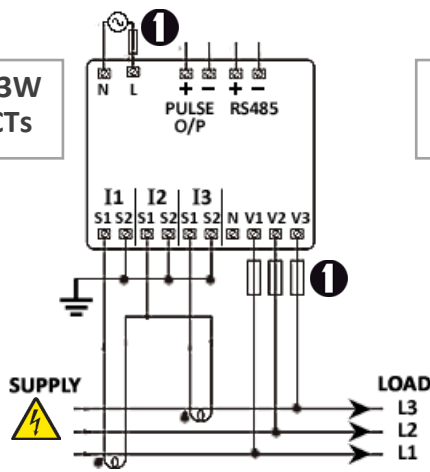

2P3W
2 CTs

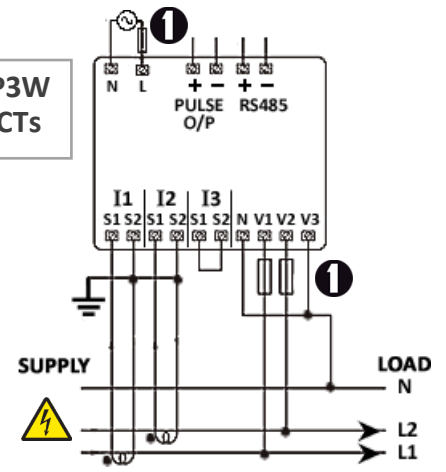

3P4W
3 CTs
3 VTs

MID ✓

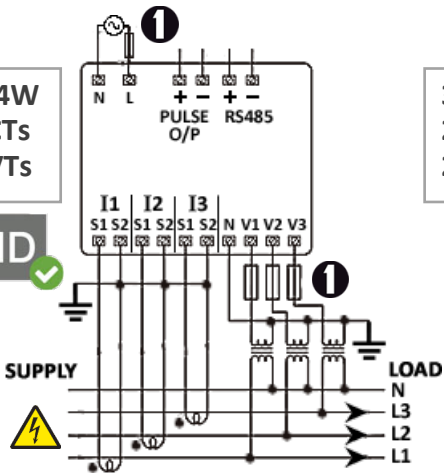

3P3W
2 CTs
2 VTs

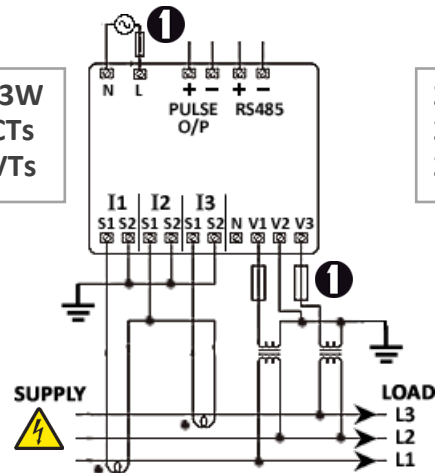

2P3W
2 CTs
2 VTs

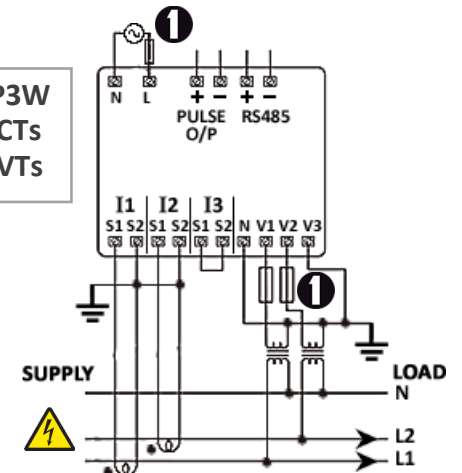

1P2W
1 CT

⚠ Voltage and current must be from same phase

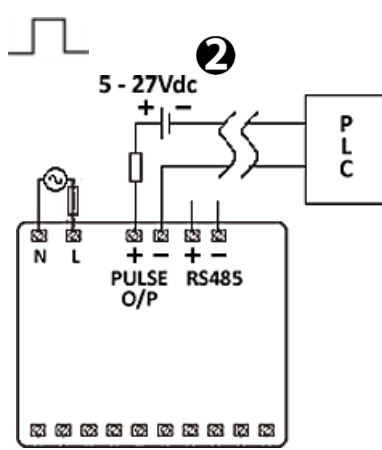
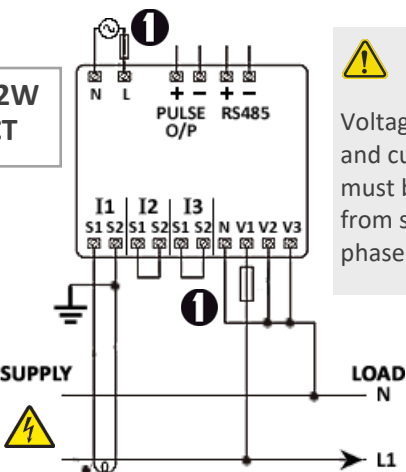

- 1 Fuse class CC UL / fast acting 600V Rating 0.5A
- 2 For 'Volt-free' PLC or digital input, voltage must be provided by the addition of a DC PSU

Single Core
0.5 > 4mm²
Ø 2.5mm max

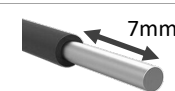

Stranded
0.5 > 2.5mm²

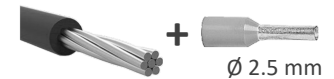

Modbus / MBus

Typical Modbus configuration shown
For MBus interface follow Wiring Topology below

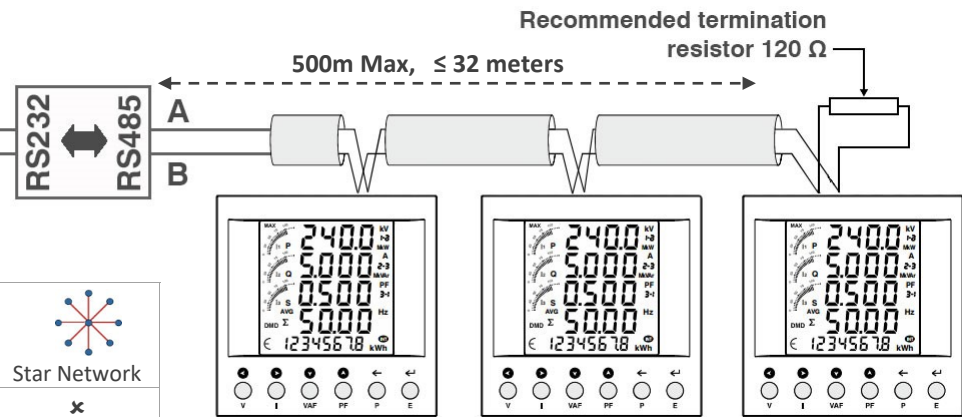
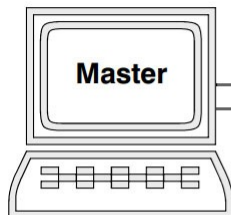

Wiring Topology	A B		
Modbus	+ -	✓	✗
MBus	1 2	✓	✓

MECHANICAL INSTALLATION

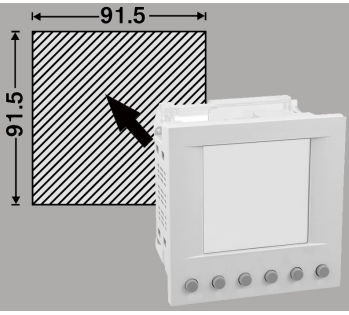

Panel mounted, installed indoor only.

The meter is intended to be installed in Mechanical Environment 'M1', with Shock and Vibrations of low significance, as per 2014/32/EC Directive.

The meter is intended to be installed in Electromagnetic Environment 'E2', as per 2014/32/EC Directive.

Installation Category III (300V L-N)

Protection Class: II Pollution degree: II

CONFIGURATION

Step A: Enter Configuration Menu

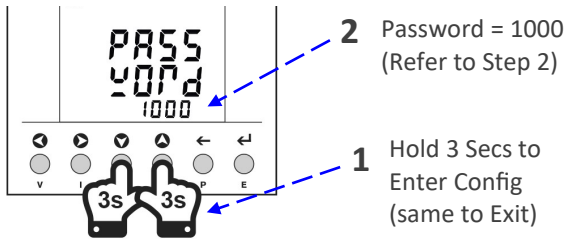

Step B: Configure each setting, as required, referring to Settings Table below, using the buttons as follow:

1		Press either button once to make digit or option flash, press again to move flashing cursor
2		Press to change digit or option, press or to move cursor position as required
3		Press to save and move to next setting option, Exit menu once all settings are configured (see Step 1)

F100-X-C	F100-X-MB	Setting	Default	Adjustment Range	Network & CT Must configure	VT Adjust if Using VT	Comms Modbus / MBus	Pulse O/P Adjust if utilised	System Settings Optional
		= MID CONFIG LOCK (refer to page.1)							
1	1	Change Password	1000	NO / YES (0000 - 9998)					✓
2	2	Phase Network Selection	3P4W	3P4W (also for 2P3W) 3P3W, 1P2W-P1, 1P2W-P2, 1P2W-P3					
3	3	CT Secondary (see CT Label)	5	1A or 5A					
4	4	CT Primary (see CT Label)	5	1A/5A > 6000A					
5	5	PT Secondary	350	173 > 415V					
6	6	PT Primary	350	100 > 600V					
7	7	Slave ID <i>Modbus:</i> <i>MBus (Primary ID):</i>	1 1	1 > 255 1 > 250			✓		
8	8	Baud rate <i>Modbus:</i> <i>MBus:</i>	9600 2400	300 > 19200 bps 1200 > 9600			✓		
9	9	Parity <i>Modbus:</i> <i>MBus:</i>	None Even	None / Odd / Even Even			✓		
10	10	Stop Bit <i>Modbus:</i> <i>MBus:</i>	1 1	1 / 2 1			✓		
11	11	Back Light Off (0000 = Never)	0000	0 > 7200 Sec					✓
12	12	Demand interval method	Sliding	Sliding / Fixed					✓
13	13	Demand interval duration	15	1 > 30					✓
14	14	Demand interval length	1	1 > 30 min					✓
15	15	Max Auto Display Pages	21	1 > 21					✓
16	16	Change Page Sequence	1 > 21	No / YES (1 > 21)					✓
17	17	Pulse Weight	0.10	00.01 > 99.99 kWh/imp					
18	18	Pulse Duration	200	50 > 300 mS				✓	
X	19	MBus Secondary ID	Serial #	0000 0000 > 9999 9999			✓		
19	20	Factory Default	No	No / Yes	Does not reset energy & demand values				
20	21	Reset Energy & Demand	No	No / Yes (Password +1)	Once entered, reset each value individually				

OPERATION

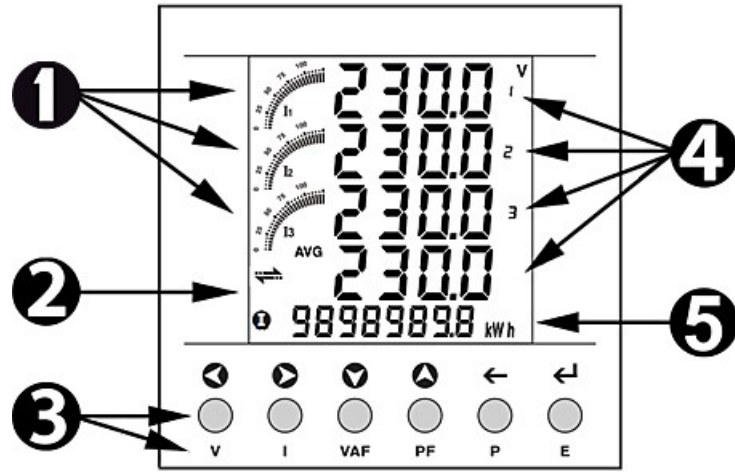

- 1 Current level bar graph (% of CT current rating)
- 2 Functions & displayed measurement indicators:
 - RS485 communication in progress
 - Integration of energy (blinks every 5 sec)
 - Σ Sum of 3-phase
 - AVG Average of 3-phase
 - DMD Max/Min Demand
 - TH Total Harmonic Distortion (THD)
 - IP Imported Energy (positive value)
 - EP Exported Energy (negative value)
 - Total Sum of 3-phase Energy (IP or EP)
 - Net Sum of IP + EP Energy
- 3 Function buttons and function symbols
- 4 Phase & total or average instantaneous measurements (V, A, PF, Hz, kW, kVAr, kVA) >> **V/I/VAF/PF/P buttons**
- 5 Energy readings (kWh/kVArh/kVAh) >> **E button**

No. of Presses	V	I	VAF	PF	P
x1	Voltage (L-N)	Current	L1: V/A/PF/Hz	Power Factor	Active Power - kW
x2	Voltage (L-L)	Current Max DMD	L2: V/A/PF/Hz	Hold 10 sec displays Serial #	Reactive Power - kVAr
x3	% THD (L-N)	% THD	L3: V/A/PF/Hz		Apparent Power - kVA
x4	% THD (L-L)	Hold 10 sec Reverse Indication 0 = None 1, 2 or 3 = Reversed	Avg: V/A/PF/Hz		L1: kW/kVAr/kVA/PF
x5					L2: kW/kVAr/kVA/PF
x6					L3: kW/kVAr/kVA/PF
x7					Σ : kW/kVAr/kVA/PF
x8					Max DMD: kW/kVAr/kVA
x9					Min DMD: kW/kVAr

1. L-N parameters are not displayed For 3P3W
2. Parameters in **BOLD** not displayed for 1P2W

	x1 > 9	Active Energy - kWh	L1 IP	L2 IP	L3 IP	L1 EP	L2 EP	L3 EP	Σ IP	Σ EP	Net (IP + EP)
	x10 > 18	Reactive Energy - kVArh	L1 IP	L2 IP	L3 IP	L1 EP	L2 EP	L3 EP	Σ IP	Σ EP	Net (IP + EP)
	x19 > 22	Apparent Energy - kVAh	L1	L2	L3	Σ	Hold 10 sec - change Page Scroll Auto <-> Manual				
	x23	Run Hour (0.01 hr = 36 sec)	Number of Auxiliary Switch ON								

Voltage Phase Sequence

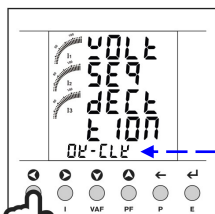

Hold 3 sec

OK-CLK: L1 → L2 → L3 ✓

ANTI-CK: Incorrect Order
INVALID Id: Missing Phase ✗