

# CONTO D6

## Three-phase energy meter

Manuale d'installazione • *Installation manual*  
Manuel d'installation • *Installationsanweisungen*





**Sommario**

Pericoli e avvertenze	4
Operazioni preliminari	5
Presentazione	6
Installazione	7
Programmazione	10
Utilizzo	19
Assistenza	22
Comunicazione	23
Caratteristiche tecniche	25
Elenco delle abbreviazioni	33

**Contents**

<i>Dangers and warnings</i>	4
<i>Preliminary operations</i>	5
<i>Presentation</i>	6
<i>Installation</i>	7
<i>Programming</i>	10
<i>Use</i>	19
<i>Assistance</i>	22
<i>Communication</i>	23
<i>Technical characteristics</i>	27
<i>List of abbreviation</i>	33

**Sommaire**

Danger et avertissement	4
Opérations préalables	5
Présentation	6
Installation	7
Programmation	10
Utilisation	19
Assistance	22
Communication	24
Caractéristiques techniques	29
Lexique des abréviations	34

**Summary**

<i>Gefahren und Warnungen</i>	4
<i>Vorarbeiten</i>	5
<i>Presentation</i>	6
<i>Installieren</i>	7
<i>Programmierung</i>	10
<i>Verwendung</i>	19
<i>Unterstützung</i>	22
<i>Kommunikation</i>	24
<i>Technische Daten</i>	31
<i>Liste der Abkürzungen</i>	34

## • Pericoli e avvertenze

Questi apparecchi devono essere montati esclusivamente da professionisti.

Il mancato rispetto delle indicazioni contenute nelle presenti istruzioni solleva il fabbricante da ogni responsabilità.

### **Rischi di folgorazione, ustioni o esplosione**

- L'installazione e la manutenzione di questo apparecchio devono essere effettuate esclusivamente da personale qualificato.
  - Prima di qualsiasi intervento sull'apparecchio, escludere gli ingressi di tensione, cortocircuitare il secondario di ciascun trasformatore di corrente ed escludere l'alimentazione ausiliaria dell'apparecchio.
  - Utilizzare sempre un opportuno dispositivo di rilevamento di tensione per confermare l'assenza di tensione.
  - Rimontare tutti i dispositivi, i portelli e i coperchi prima di mettere l'apparecchio sotto tensione.
  - Per alimentare questo apparecchio, utilizzare sempre la tensione nominale indicata.
- In caso di mancato rispetto di queste precauzioni, si potrebbero subire gravi ferite.

### **Rischi di deterioramento dell'apparecchio**

Attenzione a rispettare:

- Una tensione ai morsetti degli ingressi di tensione (U1,U2,U3 e N) secondo i valori indicati nelle sezione "Caratteristiche tecniche".
- La frequenza di rete a 50/60 Hz

## • Dangers and warnings

*This equipment must only be mounted by professionals.*

*The manufacturer shall not be held responsible for failure to comply with the instructions in this manual.*

### **Risk of electrocution, burns or explosion**

- *The device must only be installed and serviced by qualified personnel.*
  - *Prior to any work on or in the device, isolate the voltage inputs, short-circuit the secondary winding of each current transformer and exclude the device auxiliary power supply.*
  - *Always use an appropriate voltage detection device to confirm the absence of voltage.*
  - *Put all mechanisms, door and covers back in place before energising the device.*
  - *Always supply the device with the indicated rated voltage.*
- Failure to take these precautions could cause serious injuries.*

### **Risk of damaging the device**

*Check the following:*

- *The voltage to the voltage-input terminals, (U1, U2, U3 and N) according to the values indicated in the "Technical characteristics" section.*
- *The network frequency (50 / 60 Hz).*

## • Danger et avertissement

Le montage de ce produit ne peut être effectué que par des professionnels.

Le non respect des indications de la présente notice ne saurait engager la responsabilité du constructeur.

### **Risque d'électrocution, de brûlures ou d'explosion**

- L'installation et l'entretien de cet appareil ne doivent être effectués que par du personnel qualifié.
- Avant toute intervention sur l'appareil, coupez les entrées tensions, court-circuitiez le secondaire de chaque transformateur de courant et coupez l'alimentation auxiliaire de l'appareil.
- Utilisez toujours un dispositif de détection de tension approprié pour confirmer l'absence de tension.
- Remplacez tous les dispositifs, les portes et les couvercles avant de mettre cet appareil sous tension.
- Utilisez toujours la tension assignée appropriée pour alimenter cet appareil.

Si ces précautions n'étaient pas respectées, cela pourrait entraîner des blessures graves.

### **Risque de détérioration de l'appareil**

Veillez à respecter :

- Une tension aux bornes des entrées tensions (U1,U2,U3 et N) selon les valeurs indiquées dans la section "Caractéristiques techniques".
- La plage de fréquence du réseau 50/60 Hz.

## • Gefahren und Warnungen

*Diese Geräte dürfen nur von Fachleuten montiert werden.*

*Die Nichtbeachtung der vorliegenden Anweisungen entbindet den Hersteller von jeglicher Haftung.*

### **Stromschlag-, Verbrennungs- und Explosionsgefahr**

- *Die Installation und Wartung dürfen nur von qualifizierten Fachleuten vorgenommen werden.*
- *Vor jedem Eingriff in das Gerät sind die Spannungseingänge auszuschließen, der Sekundärkreis jedes Stromwandlers zu kurzschließen und die Hilfsspannungsversorgung des Gerätes auszuschließen.*
- *Verwenden Sie immer ein geeignetes Spannungsmessgerät, um die Spannungsfreiheit zu überprüfen.*
- *Alle Geräte, Türen und Abdeckungen wieder montieren, bevor Sie das Gerät unter Spannung setzen.*
- *Verwenden Sie immer die angegebene Nennspannung, um das Gerät mit Strom zu versorgen.*

*Die Nichtbeachtung dieser Vorsichtsmaßnahmen kann zu schweren Verletzungen führen.*

### **Beschädigungsgefahr des Gerätes**

*Bitte beachten:*

- *Eine Spannung an den Klemmen der Spannungseingänge (U1, U2, U3 und N) entsprechend den im Kapitel "Technische Daten" angegebenen Werten.*
- *Netzfrequenz 50/60 Hz*

### • Operazioni preliminari

Per la sicurezza del personale e del materiale, è indispensabile leggere attentamente il contenuto del presente libretto prima della messa in servizio.

Al momento del ricevimento della scatola contenente il dispositivo, è necessario verificare i seguenti punti:

- lo stato dell'imballo;
- l'assenza di danneggiamenti o rotture dovuti al trasporto;
- la rispondenza tra codice dell'apparecchio e codice ordinato;
- la presenza nell'imballo sia dell'articolo che del foglio istruzioni.

### • Preliminary operations

*For personnel and product safety read the contents of these operating instructions carefully before connecting.*

*Check the following points as soon as you receive the box containing the device:*

- the packing is in good condition;*
- the product has not been damaged or broken during transport;*
- the product reference number conforms to your order;*
- the package contains both the item and the operating instructions.*

### • Opérations préalables

Pour la sécurité du personnel et du matériel, il est impératif de bien s'imprégner du contenu de cette notice avant la mise en service.

Au moment de la réception du colis contenant le produit, il est nécessaire de vérifier les points suivants :

- l'état de l'emballage ;
- le produit n'a pas eu de dommage pendant le transport ;
- la référence de l'appareil est conforme à votre commande ;
- l'emballage comprend le produit ;
- une notice d'utilisation.

### • Vorarbeiten

*Für die Sicherheit von Personen und Material ist es unerlässlich, den Inhalt dieser Anleitung vor der Inbetriebnahme aufmerksam zu lesen. Nach Erhalt der Schachtel mit dem Gerät sind die folgenden Punkte zu überprüfen:*

- Zustand der Verpackung;*
- Das Fehlen von Beschädigungen oder Bruch durch den Transport;*
- die Übereinstimmung zwischen Gerätecode und bestelltem Code;*
- Vorhandensein in der Verpackung sowohl des Artikels als auch der Gebrauchsanweisung.*

## • Presentazione

1. Morsetto di ingresso per il conteggio dell'energia su doppia tariffa
2. Morsetto di collegamento uscita impulsi
3. Morsetto di connessione del bus di comunicazione Modbus RS485 (CE6DT1256/CE6DMID56)
4. LED metrologico
5. Tastiera composta da 3 pulsanti a doppia funzionalità (visualizzazione o configurazione)
6. Display LCD
7. Consultare manuale d'uso prima dell'installazione
8. Doppio isolamento
9. Inserzione su linea trifase 4 fili
10. Dispositivo antirotazione
11. Tensione/Corrente
12. Frequenza
13. Codice prodotto
14. Doppia tariffa
15. Uscite
16. Temperatura d'impiego
17. Classe di precisione
18. Anno di approvazione
19. Ente certificatore
20. Numero certificazione
21. Settimana e anno di fabbricazione

## • Presentation

1. Input terminal for energy metering on double tariff
2. Pulse output connection terminal
3. Modbus RS485 communication bus connection terminal (CE6DT1256/CE6DMID56)
4. Metrological LED
5. Key-pad with 3 dual-function keys (display or configuration)
6. LCD display
7. Consult the instruction manual before installation
8. Double insulation
9. Connection on 3-phase 4 wire line
10. Anti-rotation device
11. Voltage/Current
12. Frequency
13. Product code
14. Double tariff
15. Outputs
16. Working temperature
17. Accuracy class
18. Year of approval
19. Certifying board
20. Certification number
21. Manufacturing week and year

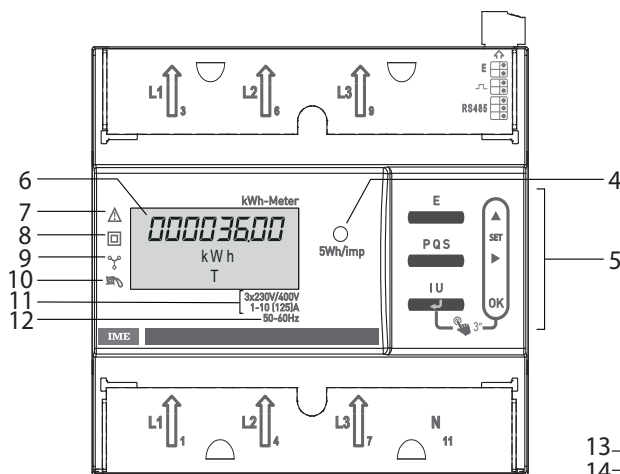

## • Présentation

1. Bornier entrée pour le comptage de l'énergie en double tarif
2. Bornier sortie impulsions
3. Bornier de connexion du bus de communication Modbus RS485 (CE6DT1256/CE6DMID56)
4. LED Metrologique
5. Clavier 3 touches pour visualiser l'ensemble des mesures et modifier les paramètres de configuration
6. Afficheur LCD
7. Consulter la notice d'utilisation avant de la mise en place
8. Double isolation
9. Branchement sur ligne triphasée 4 fils
10. Dispositif de prévention d'inversion
11. Tension/Courant
12. Fréquence
13. Code du produit
14. Double tarif
15. Sorties
16. Température de fonctionnement
17. Classe de précision
18. Année de certification
19. Organisme de certification
20. Numéro de certification
21. Semaine et année de fabrication

## • Presentation

1. Eingangsklemme zum Zählen von Energie im Doppeltarif
2. Anschlussklemmen Impulsausgang
3. Anschlussklemme des Bus der Modbus-Kommunikation RS485 (CE6DT1256/CE6DMID56)
4. Metrologie LED
5. Tastatur bestehend aus 3 Tasten mit Doppelfunktion (Display oder Konfiguration)
6. LCD-Anzeige
7. Bitte lesen das Handbuch bevor den Einbau
8. Doppelisolierung
9. Drehstromleitung 4 Leiter
10. Verdrehsicherung
11. Spannung/Strom
12. Frequenz
13. Produktcode
14. Doppeltarif
15. Ausgänge
16. Betriebstemperatur
17. Genauigkeitsklasse
18. Anlegungsyear
19. Zertifizierungsstelle
20. Zertifizierungsnummer
21. Woche und Herstellungsjahr

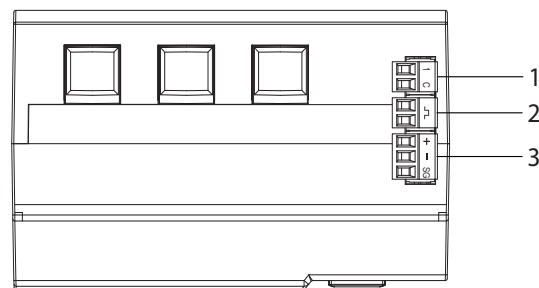

Etichetta MID • MID Label • Etiquette MID • Etiketten MID

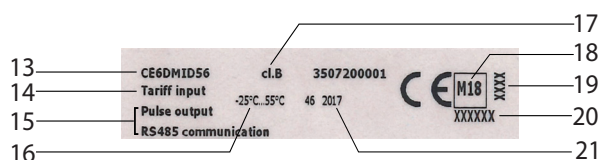

• **Installazione • Installation • Installation • Installieren**

• **Prescrizioni**

- Evitare la vicinanza con sistemi generatori di perturbazioni elettromagnetiche.

• **Recommendations**

- Avoid proximity to systems which generate electromagnetic interference.

• **Recommendations**

- Éviter la proximité avec des systèmes générateurs de perturbations électromagnétiques

• **Rezepte**

- Nähe zu Generatorsystemen vermeiden elektromagnetische Störungen.

• **Collegamento**

Per la coppia di serraggio massima dei morsetti vedere la tabella

• **Connection**

For the maximum terminal torque see the table

• **Raccordement**

Pour le couple de serrage maximal des bornes voir le tableau

• **Anschluss**

Das maximale Anzugsmoment der Klemmen finden Sie in der Tabelle

<b>U</b>	197...480 V~ (three phase)	CAT III
<b>I</b>	$I_{max} = 0,5 A$ $I_n = 10 A$ $I_{max} = 125 A$ $I_n = 1 A$	
<b>cl.</b>	CE6DT125.	Wh: 1 (E <sub>s</sub> , EN 62053-21) varh: 1 (E <sub>vy</sub> , EN 62053-23)
	CE6DMID5.	B (EN 50470-1, -3)
	5 Wh/imp.	
<b>COM</b>	RS485 Modbus	
	MAX 1 x 16 mm <sup>2</sup>	Recommended torque 1Nm 0,8 x 4mm
	1 x 16 mm <sup>2</sup>	
	1 x 16 mm <sup>2</sup>	
	MAX 1 x 35 mm <sup>2</sup>	Recommended torque 3Nm COMBI PZ2
	1 x 35 mm <sup>2</sup>	
	1 x 50 mm <sup>2</sup>	
 RS485	MAX 1 x 1 mm <sup>2</sup>	Recommended torque 0,2Nm 0,5 x 2,5mm
	1 x 1 mm <sup>2</sup>	
	1 x 1,5 mm <sup>2</sup>	
	(-5°C) - (55°C)	

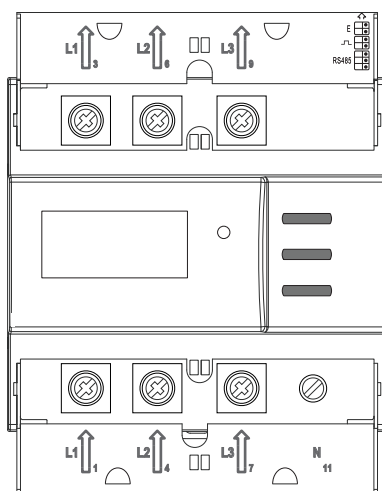

• **Alimentazione ausiliaria:**

derivata dalle prese di tensione (morsetti U1, U2, U3, N)

• **Auxiliary supply:**

derived from the voltage terminals (terminals U1, U2, U3, N)

• **Alimentation auxiliaire:**

derivée depuis par les prises de tension (bornes U1, U2, U3, N)

• **Hilfsversorgung:**

abgeleitet von den Spannungsanschlüssen (Klemmen U1, U2, U3, N)

## • Installazione • Installation • Installation • Installieren

- Schema di collegamento RS485 • *RS485 wiring diagram* • Schéma de raccordement RS485
- Anschlussbilder RS485

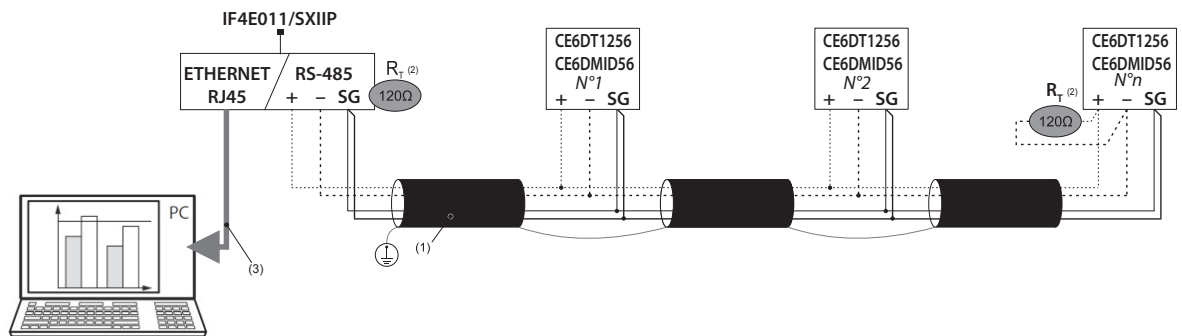

<sup>(1)</sup> BELDEN 9842, BELDEN 3106A (or/equivalent) max. 1000 m Cat. 6 (FTP/UTP) max. 50 m

<sup>(2)</sup> Resistenza non fornita a corredo da collegare tra "+" e "-" del 1° e dell'ultimo dispositivo della linea

- *Resistance not furnished to be connected between "+" and "-" of the 1st and last device of the line*
- *Résistance non fournie pour être connectée entre "+" et "-" du 1er et dernier dispositif de la ligne*
- *Der Widerstand wird nicht für die Verbindung zwischen "+" und "-" des ersten und letzten Geräts der Leitung geliefert*

<sup>(3)</sup> Ethernet: Cat. 6 (FTP/UTP)



Indirizzo Modbus, *Modbus Address, Adresse Modbus, Modbus-Adresse*: 5  
 Velocità, *Baud Rate, Vitesse, Geschwindigkeit*: 19,2 kbps  
 Parità, *Parity, Parité, Parität: Pari, Even, Paire, Gleich*



• **Installazione • Installation • Installation • Installieren**

• **Schema di collegamento • Wiring diagram • Schéma de câblage • Anschlussbilder**

- Nei cablaggi rispettare scrupolosamente lo schema di inserzione; una inesattezza nei collegamenti può pregiudicare il corretto funzionamento o causare danni allo strumento.
- *During wiring carefully comply with the connection diagram; a connection error may affect proper operation, or cause damage to the device.*
- Veuillez respecter scrupuleusement le schéma de connexion; une erreur de connexion peut nuire au bon fonctionnement, ou causer des dommages à l'appareil.
- *Beachten Sie bei der Verdrahtung unbedingt das Anschlusschema; Ungenauigkeiten in den Anschlüssen können zu Fehlbedienungen oder Schäden am Gerät führen.*

- **Rete trifase 4 fili**
- **Three-phase 4 wire network**
- **Réseau triphasé 4 fils**
- **Drehstromnetz 4 Leiter**

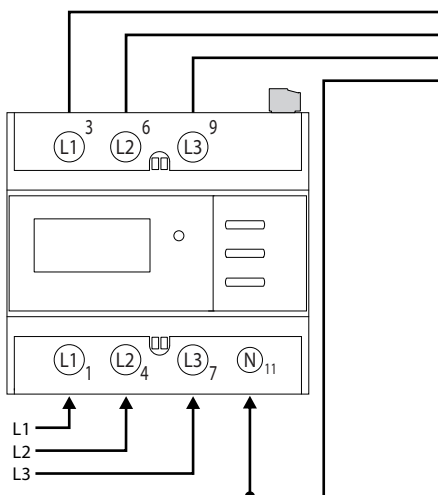

• **Schema di collegamento per doppia tariffa • Wiring diagram for double tariff**  
 • **Schéma de raccordement double tarif • Schaltplan für Doppeltarif**

- **Collegamento dell'ingresso**
- **Input connection**
- **Connexion de l'entrée**
- **Eingangsverbindung**

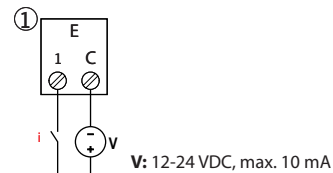
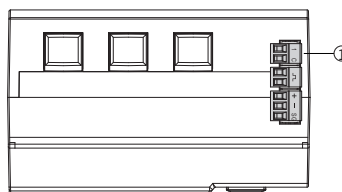

		<b>i</b>
Tar 1	☀	0
Tar 2	☾	1

**• Programmazione • Programming • Programmation • Programmierung**

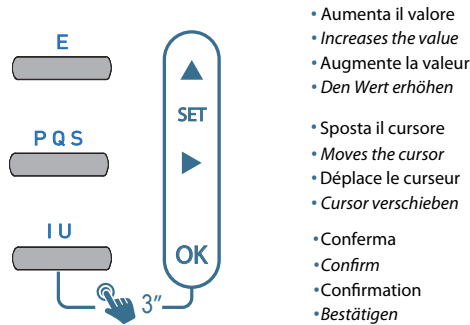

- Per accedere alla programmazione - Password = CodE1000
- To access programming - Password = CodE1000
- Pour accéder à la programmation - Mot de passe = CodE1000
- Zugriff auf die Programmierung - Kennwort = CodE1000

- E' possibile entrare in fase di programmazione da qualsiasi pagina di visualizzazione
- The programming phase can be entered from any display page
- Il est possible d'accéder à la programmation depuis n'importe quelle page d'affichage
- Der Einstieg in die Programmierphase ist von jeder beliebigen Anzeigeseite aus möglich.

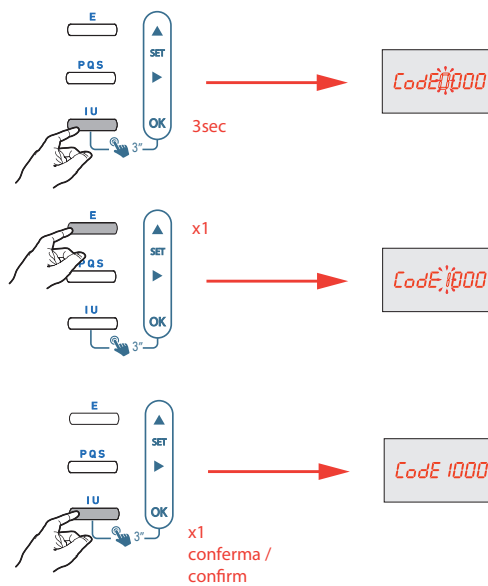

- **Nota:** Dopo 1 minuto di inattività sulla tastiera, il dispositivo esce dalla fase di programmazione senza salvataggio delle modifiche
- **Note:** After 1 minute of inactivity on the keyboard, the device exits the programming mode without saving the changes
- **Nota:** Après 1 minute d'inactivité sur le clavier, l'appareil quitte la phase de programmation sans enregistrer les modifications
- **Anmerkung:** Nach 1 Minute Inaktivität der Tastatur beendet das Gerät die Programmierphase, ohne die Änderungen zu speichern

• Programmazione • Programming • Programmation • Programmierung

- **Tempo di integrazione per il calcolo della potenza media** - Esempio: tIME = 8min
- **Integration time for average power calculation** - Example: tIME = 8min
- **Temps d'intégration pour le calcul de la puissance moyenne** - Exemple: tIME = 8min
- **ntegrationszeit zur Berechnung der mittleren Leistung** - Beispiel: tIME = 8min

- **Valori selezionabili:** 5 - 8 - 10 - 15 - 20 - 30 60 minuti
- **Selectable values:** 5 - 8 - 10 - 15 - 20 - 30 60 minutes
- **Valeurs sélectionnables:** 5 - 8 - 10 - 15 - 20 - 30 60 minutes
- **Anwählbare Werte:** 5 - 8 - 10 - 15 - 20 - 30 60 Minuten

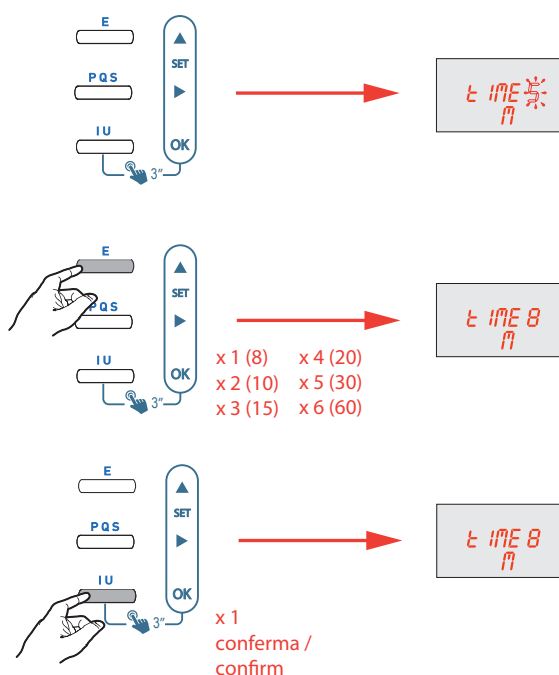

**• Programmazione • Programming • Programmation • Programmierung**

**RS485 (CE6DT1256 • CE6DMID56)**

- **Indirizzo di comunicazione** - Esempio: Addr = 105
- **Communication address** - Example: Addr = 105
- **Adresse de communication** - Exemple: Addr = 105
- **Kommunikationsadress** - Beispiel: Addr = 105

- **Valori selezionabili:** 1...255
- **Selectable values:** 1...255
- **Valeurs sélectionnables:** 1...255
- **Anwählbare Werte:** 1...255

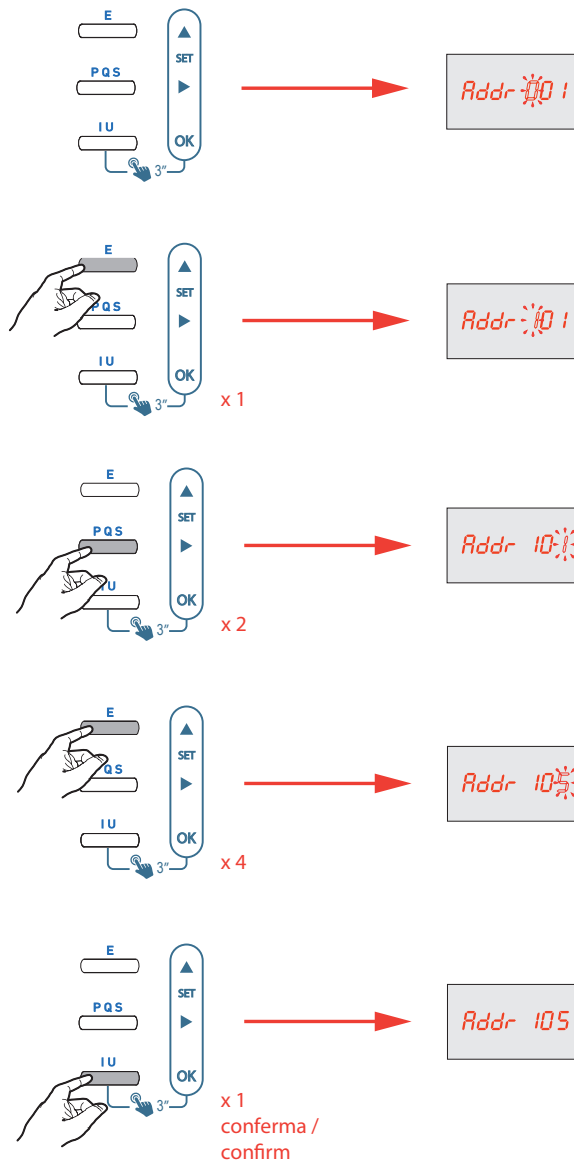

• Programmazione • Programming • Programmation • Programmierung

**RS485 (CE6DT1256 • CE6DMID56)**

- **Velocità di comunicazione** - Esempio: bAUd = 9.6
- **Communication speed** - Example: bAUd = 9.6
- **Vitesse de communication** - Exemple: bAUd = 9.6
- **Kommunikationsgeschwindigkeit** - Beispiel: bAUd = 9.6

- **Valori selezionabili:** 4.8 / 9.6 / 19.2 bit/s
- **Selectable values:** 4.8 / 9.6 / 19.2 bit/s
- **Valeurs sélectionnables:** 4.8 / 9.6 / 19.2 bit/s
- **Anwählbare Werte:** 4.8 / 9.6 / 19.2 bit/s

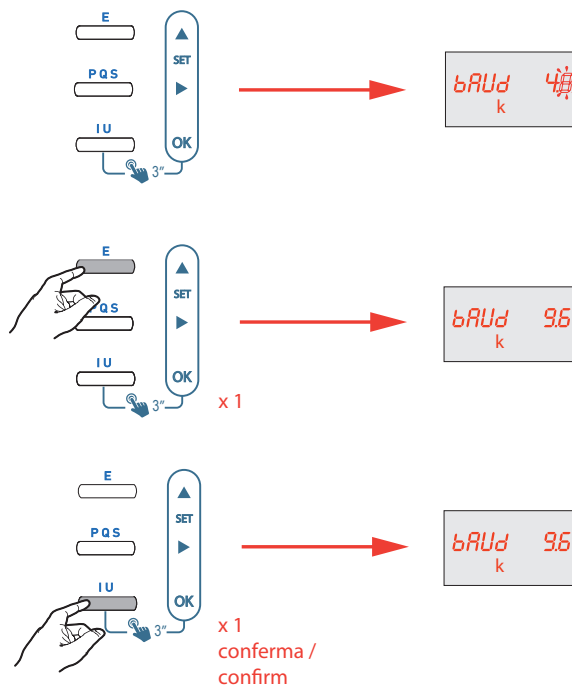

**• Programmazione • Programming • Programmation • Programmierung**

**RS485 (CE6DT1256 • CE6DMID56)**

- **Bit di parità** - Esempio: PAR = odd
- **Parity bit** - Example: PAR = odd
- **Bit de parité** - Exemple: PAR = odd
- **Paritätsbit** - Beispiel: PAR = odd
  
- **Valori selezionabili:** EVEn - odd - nonE
- **Selectable values:** EVEn - odd - nonE
- **Valeurs sélectionnables:** EVEn - odd - nonE
- **Anwählbare Werte:** EVEn - odd - nonE

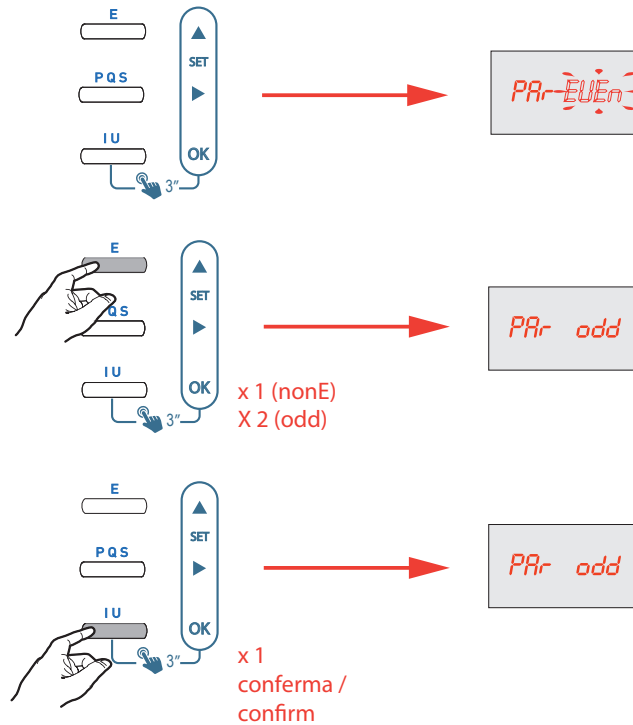

• Programmazione • Programming • Programmation • Programmierung

**RS485 (CE6DT1256 • CE6DMID56)**

- **Time Out** - Esempio: tIM = 20ms
- **Time Out** - Example: tIM = 20ms
- **Time Out** - Exemple: tIM = 20ms
- **Time Out** - Beispiel: Addr = tIM = 20ms

- **Valori selezionabili:** 3...99
- **Selectable values:** 3...99
- **Valeurs sélectionnables:** 3...99
- **Anwählbare Werte:** 3...99

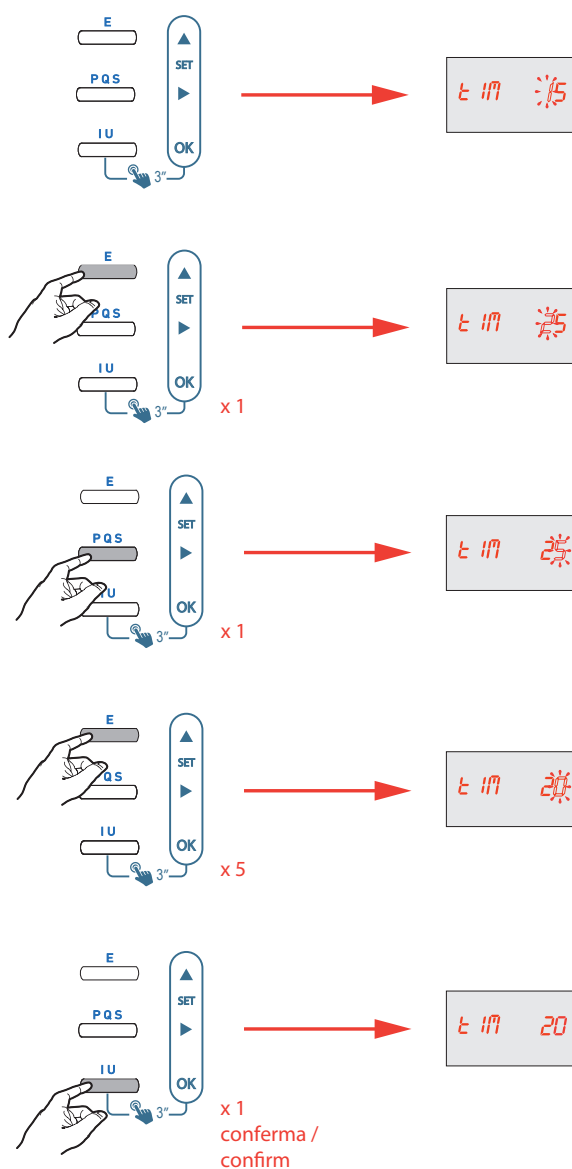

• Programmazione • Programming • Programmation • Programmierung

- Uscita impulsi
- Pulse output
- Sortie impulsion
- Impulsausgang

- Valori selezionabili: ACT (energia attiva) / rEA (energia reattiva)
- Selectable values: ACT (active energy) / rEA (reactive energy)
- Valeurs sélectionnables: ACT (energie active) / rEA (energie réactive)
- Anwählbare Werte: ACT (Wirkenergie) / rEA (Blindenergie)

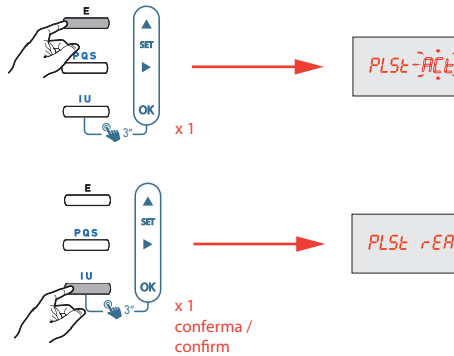

- Peso impulso Valori selezionabili: energia attiva 1imp./10Wh - 1imp./100Wh - 1imp./1000Wh - 1imp./10kWh - 1imp./100kWh  
energia reattiva 1imp./10varh - 1imp./100varh - 1imp./1000varh - 1imp./10kvarh - 1imp./100kvarh
- Pulse weight Selectable values: active energy 1pulse/10Wh - 1pulse/100Wh - 1pulse/1000Wh - 1pulse/10kWh - 1pulse/100kWh  
reactive energy 1pulse/10varh - 1pulse/100varh - 1pulse/1000varh - 1pulse/10kvarh - 1imp./100kvarh
- Poids impulsion Valeurs sélectionnables: energie active 1imp./10Wh - 1imp./100Wh - 1imp./1000Wh - 1imp./10kWh - 1imp./100kWh  
energie reactive 1imp./10varh - 1imp./100varh - 1imp./1000varh - 1imp./10kvarh - 1imp./100kvarh
- Impulsgewicht Anwählbare Werte: Wirkenergie 1imp./10Wh - 1imp./100Wh - 1imp./1000Wh - 1imp./10kWh - 1imp./100kWh  
Blindenergie 1imp./10varh - 1imp./100varh - 1imp./1000varh - 1imp./10kvarh - 1imp./100kvarh

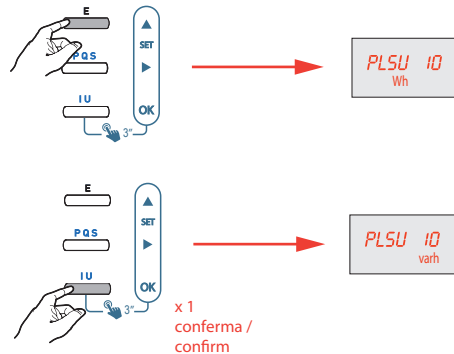

- Durata impulso Valori selezionabili: 50 - 100 - 200 - 300 - 400 - 500 ms - Esempio: PLSd 100
- Pulse width Selectable values: 50 - 100 - 200 - 300 - 400 - 500 ms - Example: PLSd 100
- Durée d'impulsion Valeurs sélectionnables: 50 - 100 - 200 - 300 - 400 - 500 ms - Exemple: PLSd 100
- Impulsdauer Anwählbare Werte: 50 - 100 - 200 - 300 - 400 - 500 ms - Beispiel: PLSd 100

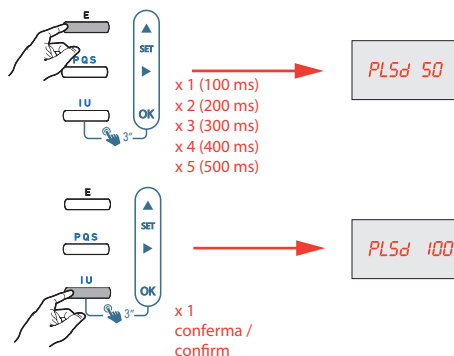



• Programmazione • Programming • Programmation • Programmierung

- Soglia di potenza attiva 3-fase, avviamento conteggio orario
- 3-phase active power threshold, start time counting
- Seuil de puissance active triphasée, commencer décompte du temps
- 3-phasiger Wirkleistungsgrenzwert, Start Stundenzähler

- **Valori selezionabili:** 0,4...50%Pn - Pn = energia attiva 3-fase (riferito a 400V 10A = 6900W) - Esempio: thr = 02.40
- **Selectable values:** 0,4...50%Pn - Pn = 3-Phase active energy (referred to 400V 10A = 6900W) - Example: thr = 02.40
- **Valeurs sélectionnables:** 0,4...50%Pn - Pn = Énergie active triphasée (mentionné 400V 10A = 6900W)- Exemple: thr = 02.40
- **Anwählbare Werte:** 0,4...50%Pn - Pn = Wirkenergie 3-phasig (bezogen auf 400V 10A = 6900W)- Beispiel: thr = 02.40

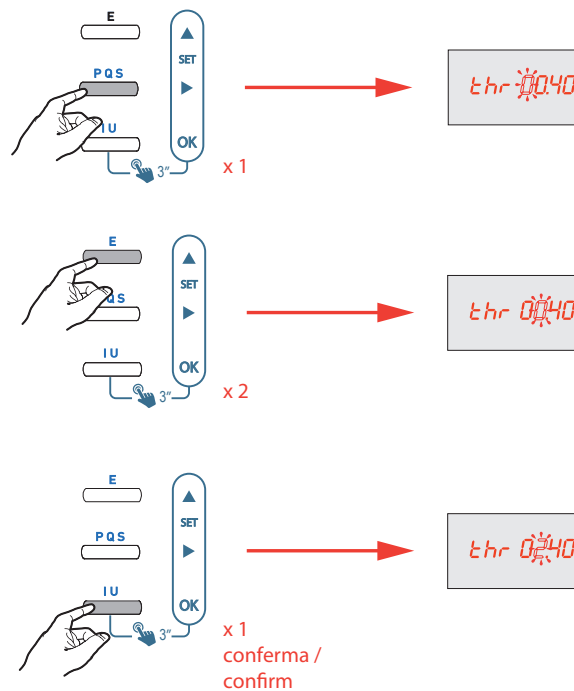

**• Programmazione • Programming • Programmation • Programmierung**

- **Cambio Password** = PSU 2000
- **Change Password** = PSU 2000
- **Modifier le mot de passe** = PSU 2000
- **Kennwort ändern** = PSU 2000

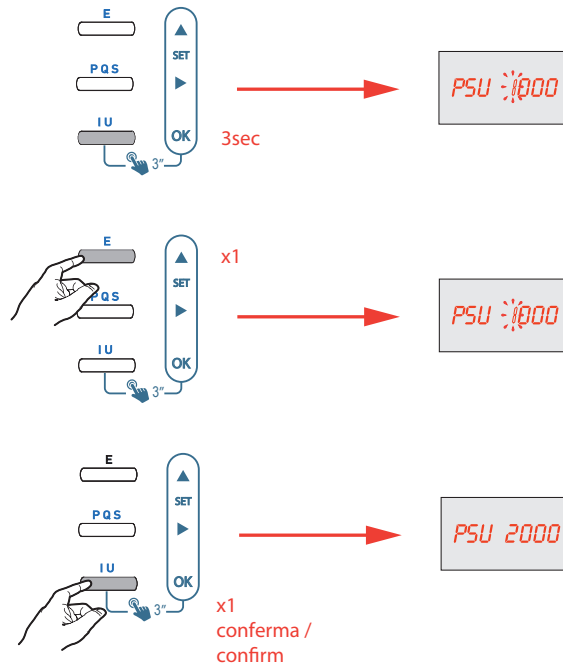

- **Importante!** Per accedere al sistema in un momento successivo è richiesta l'ultima password salvata. Si raccomanda di annotarsi la nuova password e conservarla in luogo sicuro.
- **Important!** *The last password saved must be used for future access. Remember to make a note of the new password and store it in a secure place.*
- **Important!** Lors d'un accès ultérieur, il est nécessaire d'utiliser le dernier mot-clé enregistré. N'oubliez pas de noter le mot-clé et de le conserver dans un endroit sûr.
- **Wichtig!** *Um zu einem späteren Zeitpunkt auf das System zugreifen zu können, ist das zuletzt gespeicherte Kennwort erforderlich. Bitte notieren Sie sich das neue Kennwort und bewahren Sie es an einem sicheren Ort auf*

- **Salvataggio delle impostazioni**
- **Saving settings**
- **Sauvegarde des réglages**
- **Einstellungen speichern**

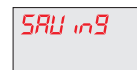

• Utilizzo • Use • Utilisation • Verwendung



Energia attiva totale  
Total active energy  
Energie active totale  
Wirkenergie insgesamt



Energia attiva parziale  
Partial active energy  
Energie active partielle  
Wirkenergie Zwischensumme



Azzeramento  
Reset  
Remise à zéro  
Nullstellung

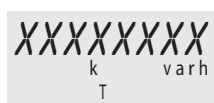

Energia reattiva totale  
Total reactive energy  
Energie réactive totale  
Blindenergie insgesamt



Energia reattiva parziale  
Partial reactive energy  
Energie réactive partielle  
Blindenergie Zwischensumme



Azzeramento  
Reset  
Remise à zéro  
Nullstellung



Energia attiva tariffa 1  
Active energy tariff 1  
Energie active tarif 1  
Wirkenergie Tarif 1



Picco di potenza attiva media tariffa 1  
Average active power demand tariff 1  
Val. max. puissance moyenne active tarif 1  
Wirkleistungsspitzenwert im Durchschnitt Tarif 1



Azzeramento  
Reset  
Remise à zéro  
Nullstellung



Energia attiva tariffa 2  
Active energy tariff 2  
Energie active tarif 2  
Wirkenergie Tarif 2



Picco di potenza attiva media tariffa 2  
Average active power demand tariff 2  
Val. max. puissance moyenne active tarif 2  
Wirkleistungsspitzenwert im Durchschnitt Tarif 2



Azzeramento  
Reset  
Remise à zéro  
Nullstellung



Energia reattiva tariffa 1  
Reactive energy tariff 1  
Energie réactive tarif 1  
Blindenergie Tarif 1

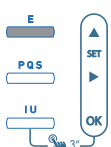

Potenza media  
Average power  
Puissance moyenne  
Leistungsmittelwert



Energia reattiva tariffa 2  
Reactive energy tariff 2  
Energie réactive tarif 2  
Blindenergie Tarif 2

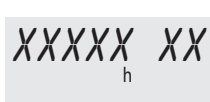
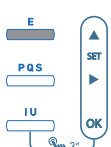

Contaore (ore-minuti)  
Hour meter (hours - minutes)  
Compteur horaire (heures, minutes)  
Stundenzähler (Stunden - Minuten)



Versione HW (X) - SW (YYY) e MD solo per la versione MID  
HW (X) - SW (YYY) version and MD only MID Version  
Version HW (X) - SW (YYY) et MD seulement pour la version MID  
Version HW (X) - SW (YYY) und MD nur für die Version MID



• **Utilizzo • Use • Utilisation • Verwendung**

<p>Potenza attiva trifase Three-phase active power Puissance active triphasée Dreiphasenwirkleistung</p>		<p>Potenza reattiva L2 Reactive power L2 Puissance réactive L2 Blindleistung L2</p>	
<p>Potenza attiva L1 Active power L1 Puissance active L1 Wirkleistung L1</p>		<p>Potenza reattiva L3 Reactive power L3 Puissance réactive L3 Blindleistung L3</p>	
<p>Potenza attiva L2 Active power L2 Puissance active L2 Wirkleistung L2</p>		<p>Potenza apparente trifase Three-phase apparent power Puissance apparente triphasée Dreiphasenscheinleistung</p>	
<p>Potenza attiva L3 Active power L3 Puissance active L3 Wirkleistung L3</p>		<p>Fattore di potenza trifase Three-phase power factor Facteur de puissance triphasée Dreiphasenleistungsfaktor</p>	
<p>Potenza reattiva trifase Three-phase reactive power Puissance réactive triphasée Dreiphasenblindleistung</p>		<p>Fattore di potenza L1 Power factor L1 Facteur de puissance L1 Leistungsfaktor L1</p>	
<p>Potenza reattiva L1 Reactive power L1 Puissance réactive L1 Blindleistung L1</p>		<p>Fattore di potenza L2 Power factor L2 Facteur de puissance L2 Leistungsfaktor L2</p>	
		<p>Fattore di potenza L3 Power factor L3 Facteur de puissance L3 Leistungsfaktor L3</p>	

• Utilizzo • Use • Utilisation • Verwendung



Corrente L1  
Current L1  
Courant L1  
Strom L1

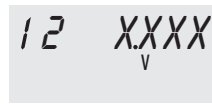

Tensione concatenata L1-L2  
Linked voltage L1-L2  
Tension composée L1-L2  
Verkettete Spannung L1-L2

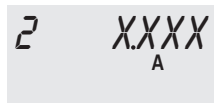

Corrente L2  
Current L2  
Courant L2  
Strom L2

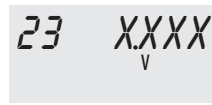

Tensione concatenata L2-L3  
Linked voltage L2-L3  
Tension composée L2-L3  
Verkettete Spannung L2-L3



Corrente L3  
Current L3  
Courant L3  
Strom L3

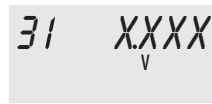

Tensione concatenata L3-L1  
Linked voltage L3-L1  
Tension composée L3-L1  
Verkettete Spannung L3-L1

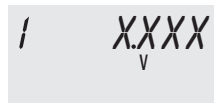

Tensione di fase L1-N  
Phase voltage L1-N  
Tension simple L1-N  
Phasenspannung L1-N



Frequenza  
Frequency  
Fréquence  
Frequenz

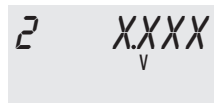

Tensione di fase L2-N  
Phase voltage L2-N  
Tension simple L2-N  
Phasenspannung L2-N

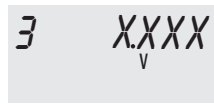

Tensione di fase L3-N  
Phase voltage L3-N  
Tension simple L3-N  
Phasenspannung L3-N



**• Assistenza**

- **Apparecchio spento o valori misurati = 0**  
Verificare il collegamento

**• Assistance**

- **Device switched off or measured values = 0**  
*Check the connection*

**• Assistance**

- **Appareil éteint ou valeurs = 0**  
Vérifiez le raccordement

**• Unterstützung**

- **Gerät ausgeschaltet oder gemessene Werte = 0**  
*Anschluss kontrollieren*

## • Comunicazione

I contatori di energia "**CE6DT1256 - CE6DMID56**" comunica utilizzando il protocollo MODBUS® che implica un dialogo secondo una logica master/slave.

Tipologia di indirizzamento:

- punto-punto (il master comunica con un solo dispositivo slave alla volta).

La comunicazione avviene con modalità RTU (Remote Terminal Unit).

### Sintassi di comunicazione

Per la sintassi standard di comunicazione fare riferimento alla Tabella di comunicazione Modbus

Conformemente al protocollo MODBUS®, affinché un il messaggio sia considerato valido dai "**CE6DT1256 - CE6DMID56**", il tempo massimo di attesa tra due parti del messaggio stesso deve essere inferiore a 3,5 volte il cosiddetto "tempo di intercarattere" (carattere = 8bit di dati).

I codici delle funzioni utilizzate sono i seguenti:

**3:** per la lettura simultanea di più registri o word

**10:** per la scrittura simultanea di più registri o word

#### Nota:

1 word <=> 2 bytes <=> 16 bits

2 word <=> 4 bytes <=> 32 bits

#### Nota:

Il tempo di risposta (time out domanda/risposta) è inferiore a 200 ms

### Tabelle di comunicazione

> Le tabelle di comunicazione MODBUS sono disponibili sul sito <http://www.imeitaly.com/> inserendo i codici "**CE6DT1256 - CE6DMID56**" nel campo di ricerca.

## • Communication

The "**CE6DT1256 - CE6DMID56**" energy counters communicate using the MODBUS® protocol which implies a dialogue using a master-slave logic structure.

Addressing type:

- point-point (the master communicates one slave at once).

The communication takes place with RTU (Remote Terminal Unit) mode.

### Communication syntax

For the standard communication syntax, refer to the Modbus communication table

According to the MODBUS® protocol, for the "**CE6DT1256 - CE6DMID56**" to consider the message to be valid, the maximum waiting time between two parts of the message itself must be less than 3.5 times the "intercharacter time" (character = 8bit data).

The following function codes are used:

**3:** to read several registers or words simultaneously

**10:** to write several registers or words simultaneously

#### Nota:

1 word <=> 2 octets <=> 16 bits

2 words <=> 4 octets <=> 32 bits

#### Nota:

The response time (question/answer time out) is 200 ms maximum.

### Communication table

> The MODBUS communication tables are available on the <http://www.imeitaly.com/> site entering the "**CE6DT1256 - CE6DMID56**" codes in the search field

## • Communication

Les produit "**CE6DT1256 - CE6DMID56**" communique à partir d'un protocole MODBUS® qui implique un dialogue selon une structure maître/esclave.

Type d'adressage:

- le maître dialogue avec un esclave le produit "**CE6DT1256 - CE6DMID56**" et attend la réponse

Le mode de communication est le mode RTU (Remote Terminal Unit) avec des caractères hexadécimaux composés au minimum de 8 bits.

### Trame de communication standard

Elle est composée de :

Conformément au protocole MODBUS®, le temps intercaractère doit être  $\leq$  à 3 silences.

C'est-à-dire au temps d'émission de 3 caractères pour que le message soit traité par le produit "**CE6DT1256 - CE6DMID56**" (1 caractère = 8 bits).

Pour exploiter correctement les informations, il est indispensable d'utiliser les fonctions suivant les codes :

- 3:** pour la lecture de n mots
- 10:** pour l'écriture de n mots

### Nota:

1 mot  $\Leftrightarrow$  2 octets  $\Leftrightarrow$  16 bits  
2 mots  $\Leftrightarrow$  4 octets  $\Leftrightarrow$  32 bits

### Remarque:

Le temps de réponse (time out question/réponse) est de 200 ms maximum.

### Table de communication

> Les tables de communication sont disponibles sur le site Web <http://www.imeitaly.com/>, en tapant "**CE6DT1256 - CE6DMID56**" dans le champ de recherche.

## • Kommunikation

Die Energiezähler "**CE6DT1256 - CE6DMID56**" kommunizieren über das MODBUS®-Protokoll, was einen Dialog nach einer Master/Slave-Logik impliziert.

Adressierungsart:

- Punkt-zu-Punkt (der Master kommuniziert mit jeweils nur einem Slave-Gerät).

Die Kommunikation erfolgt im RTU-Modus (Remote Terminal Unit).

### Kommunikationssyntax

Die Standard-Kommunikationssyntax entnehmen Sie bitte der Modbus-Kommunikationstabelle.

Nach dem MODBUS®-Protokoll muss die maximale Wartezeit zwischen zwei Teilen der Nachricht selbst weniger als das 3,5-fache der sogenannten "Zwischenzeit" (Zeichen = 8 Bit Daten) betragen, damit eine Nachricht von "**CE6DT1256 - CE6DMID56**" als gültig betrachtet werden kann.

Die verwendeten Funktionscodes lauten wie folgt:

- 3:** zum Lesen von mehreren Registern oder Wörtern gleichzeitig
- 10:** zum Schreiben von mehreren Registern oder Wörtern gleichzeitig

### Anmerkung:

1 word  $\Leftrightarrow$  2 bytes  $\Leftrightarrow$  16 bits  
2 word  $\Leftrightarrow$  4 bytes  $\Leftrightarrow$  32 bits

### Anmerkung:













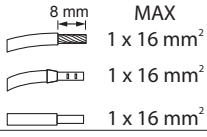
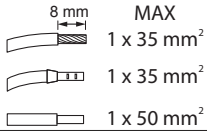
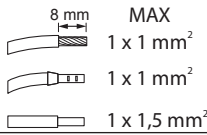



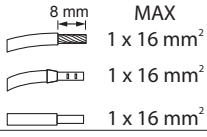
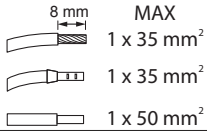
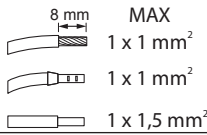

Die Antwortzeit (Time Out Frage/Antwort) beträgt weniger als 200 ms.

### Kommunikationstabelle

> Die MODBUS-Kommunikationstabellen stehen unter <http://www.imeitaly.com/> zur Verfügung, indem Sie im Suchfeld die Codes "**CE6DT1256 - CE6DMID56**" eingeben.

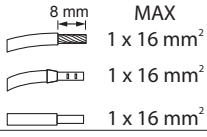
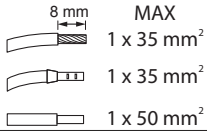
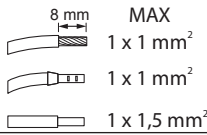

• Caratteristiche tecniche













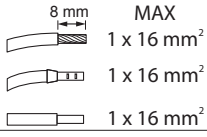
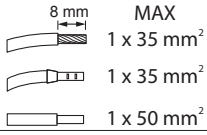
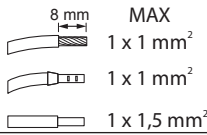



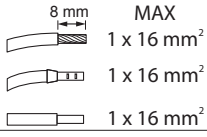
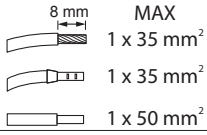
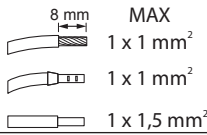

Involucro										
Dimensioni (l x h x p)	107,2 x 111,5 x 65,6mm									
Collegamenti	<table border="1" style="width: 100%; border-collapse: collapse;"> <tr> <td style="text-align: center; vertical-align: middle;">  N                 </td> <td style="text-align: center; vertical-align: middle;">  U1-U2-U3                 </td> <td style="text-align: center; vertical-align: middle;">  E RS485                 </td> </tr> <tr> <td style="text-align: center; vertical-align: middle;">  </td> <td style="text-align: center; vertical-align: middle;">  </td> <td style="text-align: center; vertical-align: middle;">  </td> </tr> <tr> <td style="text-align: center; vertical-align: middle;">  Recommended torque: 1 Nm 0,8 x 4mm                 </td> <td style="text-align: center; vertical-align: middle;">  Recommended torque: 3 Nm COMBI PZ2                 </td> <td style="text-align: center; vertical-align: middle;">  Recommended torque: 0,2 Nm 0,5 x 2,5mm                 </td> </tr> </table>	 N	 U1-U2-U3	 E RS485				 Recommended torque: 1 Nm 0,8 x 4mm	 Recommended torque: 3 Nm COMBI PZ2	 Recommended torque: 0,2 Nm 0,5 x 2,5mm
 N	 U1-U2-U3	 E RS485								
										
 Recommended torque: 1 Nm 0,8 x 4mm	 Recommended torque: 3 Nm COMBI PZ2	 Recommended torque: 0,2 Nm 0,5 x 2,5mm								
Grado di protezione:	Frontale IP54, Morsetti IP20									
Peso:	500 g									
Display										
Tipo:	LCD retroilluminato									
Alimentazione ausiliaria										
Derivata dalle prese di tensione (morsetti U1, U2, U3,N)										
Misura										
Rete trifase 4 fili										
<b>Tensione (TRMS)</b> Misura diretta										
Cod. CE6DT1252 -CE6DT1256	3x230V / 400V AC (trifase) ± 15%									
Cod. CE6DMID52 -CE6DMID56										
Autoconsumo circuito di tensione:	Max. 1,5VA (1,5W) trifase									
<b>Corrente (TRMS)</b> Misura diretta	Imin: 0,5A Itr: 1A Ib: 10A (CE6DT1252 - CE6DT1256), Iref: 10A (CE6DMID52 - CE6DMID56), Imax. 125A									
Autoconsumo circuito di corrente	Max. 2,5W per fase									
Sovraccarico di breve durata (IEC/EN 62053-21, IEC/EN 62053-23):	30 I <sub>max</sub> / 10ms									
Frequenza										
Cod. CE6DT1252 -CE6DT1256	47...63 Hz									
Cod. CE6DMID52 -CE6DMID56	49...51 Hz, 59...61Hz									
Energie										
Cod. CE6DT1252 -CE6DT1256	Classe di precisione Energia Attiva: 1 (IEC/EN 62053-21) Classe di precisione Energia Reattiva: 2 (IEC/EN 62053-23)									
Cod. CE6DMID52 -CE6DMID56	Classe di precisione: B (EN 50470-1, -3)									

## • Caratteristiche tecniche

Ingressi digitali	
Tensione:	12-24V DC
Corrente:	Max. 10 mA
Uscita impulsi	
Tipo:	Optorelè con contatto SPST-NO libero da potenziale
Tensione:	Max. 27 V AC/DC
Corrente:	Max. 50 mA
Condizioni di utilizzo	
Temperatura di funzionamento:	(-25°C) ÷ (55°C) [23°F ÷ 131°F]
Temperatura di immagazzinamento:	(-25°C) ÷ (70°C) [-13°F ÷ 158°F]
Umidità:	Adatto all'utilizzo in clima tropicale
Massima potenza dissipata:	≤ 10 W

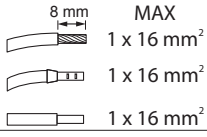
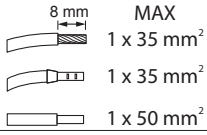
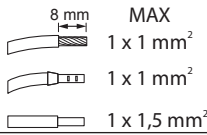
Marcatura CE	
I dispositivi <b>CE6DT1252 - CE6DT1256 / CE6DMID52 - CE6DMID56</b> sono conformi: <ul style="list-style-type: none"> <li>• Alle disposizioni della Direttiva Europea sulla compatibilità elettromagnetica (EMC) n° 2014/30/EU</li> <li>• Alla Direttiva bassa tensione n° 2014/35/UE.</li> <li>• Alla Direttiva 2011/65/EU modificata dalla direttiva 2015/863 (RoHS 2).</li> </ul>	
Compatibilità elettromagnetica	
Prove in accordo con IEC/EN 62052-11 - EN 50470-1	
Isolamento (IEC/EN 62052-11, IEC/EN 62053-21)	
Categoria di misura:	III
Grado di inquinamento:	2
Tensione di Isolamento, Ui:	300V Fase-Terra
Tenuta all'impulso:	-Ingressi di misura / Ingressi digitali I/O: onda 1,2 / 50µs 0,5 J: 6kV tensione alternata 50Hz / 1 min.: 4kV -Tutti i circuiti / Massa tensione alternata 50Hz / 1 min.: 4kV
Superficie frontale:	Classe II

• **Technical characteristics**













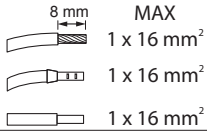
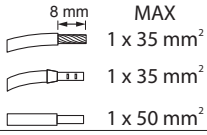
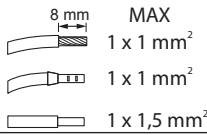



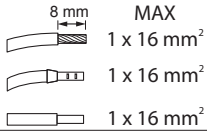
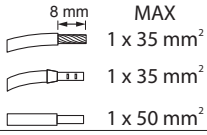
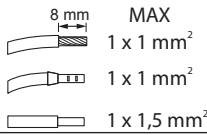

Case													
Dimension (w x h x d)	107,2 x 111,5 x 65,6mm												
Connections	<table border="1" style="width: 100%; border-collapse: collapse;"> <tr> <td style="text-align: center; vertical-align: middle;">  N                 </td> <td style="text-align: center; vertical-align: middle;">  U1-U2-U3                 </td> <td style="text-align: center; vertical-align: middle;">  E RS485                 </td> </tr> <tr> <td style="text-align: center; vertical-align: middle;">  </td> <td style="text-align: center; vertical-align: middle;">  </td> <td style="text-align: center; vertical-align: middle;">  </td> </tr> <tr> <td style="text-align: center; vertical-align: middle;">                     MAX 1 x 16 mm<sup>2</sup> 1 x 16 mm<sup>2</sup> 1 x 16 mm<sup>2</sup> </td> <td style="text-align: center; vertical-align: middle;">                     MAX 1 x 35 mm<sup>2</sup> 1 x 35 mm<sup>2</sup> 1 x 50 mm<sup>2</sup> </td> <td style="text-align: center; vertical-align: middle;">                     MAX 1 x 1 mm<sup>2</sup> 1 x 1 mm<sup>2</sup> 1 x 1,5 mm<sup>2</sup> </td> </tr> <tr> <td style="text-align: center; vertical-align: middle;">                     Recommended torque: 1 Nm 0,8 x 4mm  </td> <td style="text-align: center; vertical-align: middle;">                     Recommended torque: 3 Nm COMBI PZ2  </td> <td style="text-align: center; vertical-align: middle;">                     Recommended torque: 0,2 Nm 0,5 x 2,5mm  </td> </tr> </table>	 N	 U1-U2-U3	 E RS485				MAX 1 x 16 mm <sup>2</sup> 1 x 16 mm <sup>2</sup> 1 x 16 mm <sup>2</sup>	MAX 1 x 35 mm <sup>2</sup> 1 x 35 mm <sup>2</sup> 1 x 50 mm <sup>2</sup>	MAX 1 x 1 mm <sup>2</sup> 1 x 1 mm <sup>2</sup> 1 x 1,5 mm <sup>2</sup>	Recommended torque: 1 Nm 0,8 x 4mm 	Recommended torque: 3 Nm COMBI PZ2 	Recommended torque: 0,2 Nm 0,5 x 2,5mm 
 N	 U1-U2-U3	 E RS485											
													
MAX 1 x 16 mm <sup>2</sup> 1 x 16 mm <sup>2</sup> 1 x 16 mm <sup>2</sup>	MAX 1 x 35 mm <sup>2</sup> 1 x 35 mm <sup>2</sup> 1 x 50 mm <sup>2</sup>	MAX 1 x 1 mm <sup>2</sup> 1 x 1 mm <sup>2</sup> 1 x 1,5 mm <sup>2</sup>											
Recommended torque: 1 Nm 0,8 x 4mm 	Recommended torque: 3 Nm COMBI PZ2 	Recommended torque: 0,2 Nm 0,5 x 2,5mm 											
Degree of protection	Front face IP54, Terminals IP20												
Weight:	500 g												
Display													
Type:	Bcklighted LCD display												
Auxiliary supply													
Derived from the voltage terminals (terminals U1, U2, U3, N)													
Measurement													
Three-phase 4-wire network													
<b>Voltage (TRMS)</b> Direct measurement													
Code CE6DT1252 -CE6DT1256	3x230V / 400V AC (three-phase) ± 15%												
Code CE6DMID52 -CE6DMID56													
Power consumption voltage circuit:	Max. 1,5VA (1,5W) three-phase												
<b>Current (TRMS)</b> Direct measurement	I <sub>min</sub> : 0,5A I <sub>tr</sub> : 1A I <sub>b</sub> : 10A (CE6DT1252 - CE6DT1256), I <sub>ref</sub> : 10A (CE6DMID52 - CE6DMID56), I <sub>max</sub> : 125A												
Current circuit power consumption	Max. 2,5W per phase												
Short-time overcurrent (IEC/EN 62053-21, IEC/EN 62053-23):	30 I <sub>max</sub> / 10ms												
Frequency													
Code CE6DT1252 -CE6DT1256	47...63 Hz												
Code CE6DMID52 -CE6DMID56	49...51 Hz, 59...61Hz												
Energies													
Code CE6DT1252 -CE6DT1256	Active energy accuracy class: 1 (IEC/EN 62053-21) Reactive energy accuracy class: 2 (IEC/EN 62053-23)												
Code CE6DMID52 -CE6DMID56	Accuracy class: B (EN 50470-1, -3)												

## • Technical characteristics

<b>Digital inputs</b>	
Voltage:	12-24V DC
Current:	Max. 10 mA
<b>Pulse output</b>	
Type:	Optorelays with potential-free SPST-NO contact
Voltage:	Max. 27 V AC/DC
Current:	Max. 50 mA
<b>Operating conditions</b>	
Operating temperature:	(-25°C) ÷ (55°C) [23°F ÷ 131°F]
Storage temperature:	(-25°C) ÷ (70°C) [-13°F ÷ 158°F]
Humidity:	Suitable for tropical climates
Max. dissipated power:	≤ 10 W

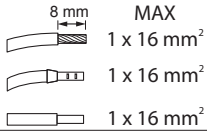
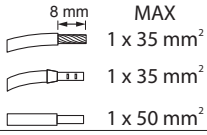
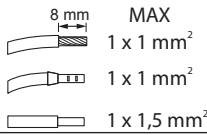
<b>CE Marking</b>	
<p>The <b>CE6DT1252 - CE6DT1256 / CE6DMID52 - CE6DMID56</b> devices comply with:</p> <ul style="list-style-type: none"> <li>• The requirements of the European directive on electromagnetic compatibility (EMC) n° 2014/30/EU</li> <li>• The low voltage directive n° 2014/35/UE.</li> <li>• Directive 2011/65/EU modified by directive 2015/863 (RoHS 2).</li> </ul>	
<b>Electromagnetic compatibility</b>	
According to IEC/EN 62052-11 - EN 50470-1	
<b>Insulation (IEC/EN 62052-11, IEC/EN 62053-21)</b>	
Measurement category:	III
Degree of pollution:	2
Insulation voltage, $U_i$ :	300V Phase-Earth
Impulse withstand voltage	<ul style="list-style-type: none"> <li>- Measuring inputs / Digital I/O inputs wave 1,2 / 50µs 0,5 J: 6kV alternate voltage 50Hz / 1 min.: 4kV</li> <li>- All circuits / earth alternate voltage 50Hz / 1 min.: 4kV</li> </ul>
Front surface:	Class II

• **Caractéristiques techniques**













































Boîtier													
Dimensions (l x h x p)	107,2 x 111,5 x 65,6mm												
Raccordement:	<table border="1" style="width: 100%; border-collapse: collapse;"> <tr> <td style="text-align: center; vertical-align: middle;">  N                 </td> <td style="text-align: center; vertical-align: middle;">  U1-U2-U3                 </td> <td style="text-align: center; vertical-align: middle;">  E RS485                 </td> </tr> <tr> <td style="text-align: center; vertical-align: middle;">  </td> <td style="text-align: center; vertical-align: middle;">  </td> <td style="text-align: center; vertical-align: middle;">  </td> </tr> <tr> <td style="text-align: center; vertical-align: middle;">                     MAX 1 x 16 mm<sup>2</sup> 1 x 16 mm<sup>2</sup> 1 x 16 mm<sup>2</sup> </td> <td style="text-align: center; vertical-align: middle;">                     MAX 1 x 35 mm<sup>2</sup> 1 x 35 mm<sup>2</sup> 1 x 50 mm<sup>2</sup> </td> <td style="text-align: center; vertical-align: middle;">                     MAX 1 x 1 mm<sup>2</sup> 1 x 1 mm<sup>2</sup> 1 x 1,5 mm<sup>2</sup> </td> </tr> <tr> <td style="text-align: center; vertical-align: middle;">  Recommended torque: 1 Nm 0,8 x 4mm                 </td> <td style="text-align: center; vertical-align: middle;">  Recommended torque: 3 Nm COMBI PZ2                 </td> <td style="text-align: center; vertical-align: middle;">  Recommended torque: 0,2 Nm 0,5 x 2,5mm                 </td> </tr> </table>	 N	 U1-U2-U3	 E RS485				MAX 1 x 16 mm <sup>2</sup> 1 x 16 mm <sup>2</sup> 1 x 16 mm <sup>2</sup>	MAX 1 x 35 mm <sup>2</sup> 1 x 35 mm <sup>2</sup> 1 x 50 mm <sup>2</sup>	MAX 1 x 1 mm <sup>2</sup> 1 x 1 mm <sup>2</sup> 1 x 1,5 mm <sup>2</sup>	 Recommended torque: 1 Nm 0,8 x 4mm	 Recommended torque: 3 Nm COMBI PZ2	 Recommended torque: 0,2 Nm 0,5 x 2,5mm
 N	 U1-U2-U3	 E RS485											
													
MAX 1 x 16 mm <sup>2</sup> 1 x 16 mm <sup>2</sup> 1 x 16 mm <sup>2</sup>	MAX 1 x 35 mm <sup>2</sup> 1 x 35 mm <sup>2</sup> 1 x 50 mm <sup>2</sup>	MAX 1 x 1 mm <sup>2</sup> 1 x 1 mm <sup>2</sup> 1 x 1,5 mm <sup>2</sup>											
 Recommended torque: 1 Nm 0,8 x 4mm	 Recommended torque: 3 Nm COMBI PZ2	 Recommended torque: 0,2 Nm 0,5 x 2,5mm											
Indice de protection:	Face avant IP54, Bornes IP20												
Poids:	500 g												
Afficheur													
Type:	LCD avec rétroéclairage												
Alimentation axiliaire													
Dérivée par le prises de tension (bornes U1, U2, U3, N)													
Mesure													
Reseau triphasé 4 fils													
<b>Tension (TRMS)</b> Mesure directe													
Cod. CE6DT1252 -CE6DT1256	3x230V / 400V AC (triphasée) ± 15%												
Cod. CE6DMID52 -CE6DMID56													
Autoconsommation circuit de tension:	Max. 1,5VA (1,5W) triphasée												
<b>Courant (TRMS)</b> Mesure directe	Imin: 0,5A Itr: 1A Ib: 10A (CE6DT1252 - CE6DT1256), Iref: 10A (CE6DMID52 - CE6DMID56), Imax. 125A												
Autoconsommation circuit de courant	Max. 2,5W par phase												
Surintensité de courte durée (IEC/EN 62053-21, IEC/EN 62053-23):	30 I <sub>max</sub> / 10ms												
Fréquence													
Cod. CE6DT1252 -CE6DT1256	47...63 Hz												
Cod. CE6DMID52 -CE6DMID56	49...51 Hz, 59...61Hz												
Energies													
Cod. CE6DT1252 -CE6DT1256	Classe de précision Energie Active: 1 (IEC/EN 62053-21) Classe de précision Energie Réactive: 2 (IEC/EN 62053-23)												
Cod. CE6DMID52 -CE6DMID56	Classe de précision: B (EN 50470-1, -3)												

## • Caractéristiques techniques

Entrée numérique	
Tension:	12-24V DC
Courant:	Max. 10 mA
Sortie impulsions	
Type:	Optorelays avec contact SPST-NO libre de potentiel
Tension:	Max. 27 V AC/DC
Courant:	Max. 50 mA
Conditions d' utilisation	
Température de fonctionnement:	(-25°C) ÷ (55°C) [23°F ÷ 131°F]
Température de stockage:	(-25°C) ÷ (70°C) [-13°F ÷ 158°F]
Humidité:	Convient pour les climats tropicaux
Dissipation thermique:	≤ 10 W

Marquage CE	
Le produits <b>CE6DT1252 - CE6DT1256 / CE6DMID52 - CE6DMID56</b> répondent aux: <ul style="list-style-type: none"> <li>• Dispositions de la directive européenne sur la compatibilité électromagnétique (CEM) n° 2014/30/UE</li> <li>• A directive basse tension n° 2014/35/EU.</li> <li>• A directive 2011/65/UE modifiée par directive 2015/863 (RoHS 2).</li> </ul>	
Compatibilité électromagnétique	
Essais conformément a IEC/EN 62052-11 - EN 50470-1	
Isolation (IEC/EN 62052-11, IEC/EN 62053-21)	
Catégorie de mesure:	III
Degré de pollution:	2
Tension d' isolation, Ui:	300V Phase-Terre
Tension de choc assignée:	- Entrée de mesure / Entrée I/O numérique: onda 1,2 / 50µs 0,5 J: 6kV tension alternatif 50Hz / 1 min.: 4kV -Tous les circuits /Terre: tension alternatif 50Hz / 1 min.: 4kV
Face avant:	Classe II

• Technische Daten

Gehäuse																
Abmessung (L x H x T)	107,2 x 111,5 x 65,6mm															
Anschlüsse	<table border="1" style="width: 100%; border-collapse: collapse;"> <tr> <td style="text-align: center;">  N                 </td> <td style="text-align: center;">  U1-U2-U3                 </td> <td style="text-align: center;">  E RS485                 </td> </tr> <tr> <td style="text-align: center;">  MAX 1 x 16 mm<sup>2</sup> </td> <td style="text-align: center;">  MAX 1 x 35 mm<sup>2</sup> </td> <td style="text-align: center;">  MAX 1 x 1 mm<sup>2</sup> </td> </tr> <tr> <td style="text-align: center;">  1 x 16 mm<sup>2</sup> </td> <td style="text-align: center;">  1 x 35 mm<sup>2</sup> </td> <td style="text-align: center;">  1 x 1 mm<sup>2</sup> </td> </tr> <tr> <td style="text-align: center;">  1 x 16 mm<sup>2</sup> </td> <td style="text-align: center;">  1 x 50 mm<sup>2</sup> </td> <td style="text-align: center;">  1 x 1,5 mm<sup>2</sup> </td> </tr> <tr> <td style="text-align: center;">  Recommended torque: 1 Nm 0,8 x 4mm                 </td> <td style="text-align: center;">  Recommended torque: 3 Nm COMBI PZ2                 </td> <td style="text-align: center;">  Recommended torque: 0,2 Nm 0,5 x 2,5mm                 </td> </tr> </table>	 N	 U1-U2-U3	 E RS485	 MAX 1 x 16 mm <sup>2</sup>	 MAX 1 x 35 mm <sup>2</sup>	 MAX 1 x 1 mm <sup>2</sup>	 1 x 16 mm <sup>2</sup>	 1 x 35 mm <sup>2</sup>	 1 x 1 mm <sup>2</sup>	 1 x 16 mm <sup>2</sup>	 1 x 50 mm <sup>2</sup>	 1 x 1,5 mm <sup>2</sup>	 Recommended torque: 1 Nm 0,8 x 4mm	 Recommended torque: 3 Nm COMBI PZ2	 Recommended torque: 0,2 Nm 0,5 x 2,5mm
 N	 U1-U2-U3	 E RS485														
 MAX 1 x 16 mm <sup>2</sup>	 MAX 1 x 35 mm <sup>2</sup>	 MAX 1 x 1 mm <sup>2</sup>														
 1 x 16 mm <sup>2</sup>	 1 x 35 mm <sup>2</sup>	 1 x 1 mm <sup>2</sup>														
 1 x 16 mm <sup>2</sup>	 1 x 50 mm <sup>2</sup>	 1 x 1,5 mm <sup>2</sup>														
 Recommended torque: 1 Nm 0,8 x 4mm	 Recommended torque: 3 Nm COMBI PZ2	 Recommended torque: 0,2 Nm 0,5 x 2,5mm														
Schutzklasse:	Frontal IP54, Klemmen IP20															
Gewicht:	500 g															
Display																
Typ:	LCD mit Rückbeleuchtung															
Hilfsspannung																
Abgeleitet von den Spannungsanschlüssen (Klemmen U1, U2, U3, N)																
Messung																
Drehstromnetz 4 Leiter																
<b>Spannung (TRMS)</b> Direkte Messung																
Cod. CE6DT1252 -CE6DT1256	3x230V / 400V AC (dreiphasig) ± 15%															
Cod. CE6DMID52 -CE6DMID56																
Selbstverbrauch Spannungskreis	Max. 1,5VA (1,5W) dreiphasig															
<b>Strom (TRMS)</b> Direkte Messung	I <sub>min</sub> : 0,5A I <sub>tr</sub> : 1A I <sub>b</sub> : 10A (CE6DT1252 - CE6DT1256), I <sub>ref</sub> : 10A (CE6DMID52 - CE6DMID56), I <sub>max</sub> : 125A															
Selbstverbrauch Stromkreis	Max. 2,5W pro Phase															
Kurzzeitige Überlastung (IEC/EN 62053-21, IEC/EN 62053-23):	30 I <sub>max</sub> / 10ms															
Frequenz																
Code CE6DT1252 -CE6DT1256	47...63 Hz															
Code CE6DMID52 -CE6DMID56	49...51 Hz, 59...61Hz															
Energie																
Code CE6DT1252 -CE6DT1256	Genauigkeitsklasse Wirkenergie: 1 (IEC/EN 62053-21) Genauigkeitsklasse Blindenergie: 2 (IEC/EN 62053-23)															
Code CE6DMID52 -CE6DMID56	Genauigkeitsklasse: B (EN 50470-1, -3)															

## • Technische Daten

<b>Digitaleingänge</b>	
Spannung:	12-24V DC
Strom:	Max. 10 mA
<b>Impulsausgang</b>	
Typ:	Optorelais mit SPST-NO Kontakt potentialfrei
Spannung:	Max. 27 V AC/DC
Strom:	Max. 50 mA
<b>Gebrauchsbedingungen</b>	
Betriebstemperatur:	(-25°C) ÷ (55°C) [23°F ÷ 131°F]
Lagertemperatur:	(-25°C) ÷ (70°C) [-13°F ÷ 158°F]
Feuchtigkeit:	Geeignet für den Einsatz in tropischem Klima
Maximale Verlustleistung:	≤ 10 W

<b>CE-Kennzeichnung</b>	
<p>Die Geräte CE6DT1252 - CE6DT1256 / CE6DMID52 - CE6DMID56 entsprechen</p> <ul style="list-style-type: none"> <li>• Den Bestimmungen der Europäischen Richtlinie über die elektromagnetische Verträglichkeit (EMV) Nr. 2014/30/EU</li> <li>• Der Niederspannungsrichtlinie 2014/35/EU</li> <li>• Der Richtlinie 2011/65/EG geändert durch Richtlinie 2015/863 (RoHS 2)</li> </ul>	
<b>Elektromagnetische Verträglichkeit</b>	
Prüfungen gemäß IEC/EN 62052-11 - EN 50470-1	
<b>Isolation (IEC/EN 62052-11, IEC/EN 62053-21)</b>	
Messkategorie:	III
Verschmutzungsgrad:	2
Isolationsspannung, U <sub>i</sub> :	300V Phase-Erde
Impulsdauer:	-Messeingänge / Digitale I / O-Eingänge: Welle 1,2 / 50µs 0,5 J: 6kV Wechselspannung 50Hz / 1 min.: 4kV -Alle Stromkreise / Masse Wechselspannung 50Hz / 1 min.: 4kV
Frontfläche:	Klasse II





**• Elenco delle abbreviazioni**

CodE	Codice d'accesso
tIME	Tempo di integrazione Potenze
Addr	Indirizzo
bAUd	Velocità di comunicazione in kbps
PAr	Parità
nonE	Parità nessuna
EVEEn	Parità pari
odd	Parità dispari
tIM	Ritardo alla risposta (ms)
PLSt	Impostazione dell'uscita impulsi
ACt	Energia attiva (kWh)
rEA	Energia reattiva (kvarh)
PLSU	Peso dell'impulso
PLSd	Durata dell'impulso
thr	Avvio del contatore orario associato alla potenza
PSU	Personalizzazione della password
SAUing	Salvataggio delle impostazioni
k	kilo (es.: kVA = kilo Volt Ampère)
M	Mega (es.: MVA = Mega Volt Ampère)
T	Valore Totale di energia
P	Valore Parziale di energia
PMD	Picco potenza media
MD	Potenza media
h	Contaore (Ore e Minuti)
Ux.yyy	Versione Firmware
☀	Conteggio energia - Tariffa 1
☾	Conteggio energia - Tariffa 2
PF	Fattore di potenza
Fr	Frequenza
I <sub>tr</sub>	Corrente transizionale
I <sub>ref</sub>	Corrente di riferimento (10I <sub>tr</sub> )

**• List of abbreviations**

<i>CodE</i>	<i>Password</i>
<i>tIME</i>	<i>Power integration time</i>
<i>Addr</i>	<i>Address</i>
<i>bAUd</i>	<i>Communication speed in kbps</i>
<i>PAr</i>	<i>Parity</i>
<i>nonE</i>	<i>No parity</i>
<i>EVEEn</i>	<i>Even parity</i>
<i>odd</i>	<i>Odd parity</i>
<i>tIM</i>	<i>Delay response (ms)</i>
<i>PLSt</i>	<i>Pulse output setting</i>
<i>ACt</i>	<i>Active energy (kWh)</i>
<i>rEA</i>	<i>Reactive energy (kvarh)</i>
<i>PLSU</i>	<i>Pulse value</i>
<i>PLSd</i>	<i>Pulse duration</i>
<i>thr</i>	<i>Starting the time counter associated with the power</i>
<i>PSU</i>	<i>Password customisation</i>
<i>SAUing</i>	<i>Saving settings</i>
<i>k</i>	<i>kilo (eg.: kVA = kilo Voltamps)</i>
<i>M</i>	<i>Mega (eg.: MVA = Mega Voltamps)</i>
<i>T</i>	<i>Total energy value</i>
<i>P</i>	<i>Parzial energy value</i>
<i>PMD</i>	<i>Average power demand</i>
<i>MD</i>	<i>Average power</i>
<i>h</i>	<i>Hour counter (Hours and Minutes)</i>
<i>Ux.yyy</i>	<i>Firmware version</i>
☀	<i>Energy counting - Tariff 1</i>
☾	<i>Energy counting - Tariff 2</i>
<i>PF</i>	<i>Power factor</i>
<i>Fr</i>	<i>Frequency</i>
<i>I<sub>tr</sub></i>	<i>Transitional current</i>
<i>I<sub>ref</sub></i>	<i>Reference current (10I<sub>tr</sub>)</i>

## • Lexique des abréviations

CodE	Mot de passe
tIME	Temps d'intégration des Puissances
Addr	Adresse de communication
bAUd	Vitesse de communication in kbps
PAr	Parité de la trame de communication
nonE	Sans parité
EVEn	Parité paire
odd	Parité impaire
tIM	Réponse delay (ms)
PLSt	Valeur associée à la sortie d'impulsion
ACt	Energie active (kWh)
rEA	Energie réactive (kvarh)
PLSU	Poids de l'impulsion
PLSd	Durée de l'impulsion
thr	Activation du compteur horaire sur la puissance
PSU	Personnalisation du mot de passe
SAUing	Sauvegarde des réglages
k	kilo (ex.: kVA = kilo Volt Ampères)
M	Mega (ex.: MVA = Mega Volt Ampères)
T	Valeur Totale d'énergie
P	Valeur Partielle d'énergie
PMD	Val. Maxi. puissance active moyenne
MD	Puissance active moyenne
h	Compteur horaire (Heures et Minutes)
Ux.yyy	Version Firmware
	Comptage énergie - Tarif 1
	Comptage énergie - Tarif 2
PF	Facteur de puissance
Fr	Fréquence
I <sub>tr</sub>	Transitional current
I <sub>ref</sub>	Reference current (10I <sub>tr</sub> )

## • Liste der Abkürzungen

CodE	Zugriffcode
tIME	Integrationszeit Leistungen
Addr	Adresse
bAUd	Kommunikationsgeschwindigkeit in kbps
PAr	Parität
nonE	Parität keine
EVEn	Parität Gleich
odd	Parität Ungerade
tIM	Antwortverzögerung (ms)
PLSt	Einstellung Impulsausgang
ACt	Wirkenergie (kWh)
rEA	Blindenergie (kvarh)
PLSU	Impulsgewicht
PLSd	Impulsdauer
thr	Starten des mit der Leistung verbundenen Zeitzählers
PSU	Kennwort nach Wunsch
SAUing	Einstellungen speichern
k	kilo (Bsp.: kVA = kilo Volt Ampère)
M	Mega (z.B.: MVA = Mega Volt Ampère)
T	Gesamtwert der Energie
P	Partieller Energiewert
PMD	Leistungsspitze
MD	Leistungsmittelwert
h	Stundenzähler (Stunden und Minuten)
Ux.yyy	Firmware-Version
	Energiezählung - Tarif 1
	Energiezählung - Tarif 2
PF	Leistungsfaktor
Fr	Frequenz
I <sub>tr</sub>	Übergangstrom
I <sub>ref</sub>	Bezugsstrom (10I <sub>tr</sub> )



**IME**

BTicino S.p.A  
Viale Borri, 231  
21100 Varese (VA) ITALY  
☎: +39 02 44 878.1  
Fax : +39 02 45 86 76 63  
[www.imeitaly.com](http://www.imeitaly.com)